

Interact Xpress Software

User Guide



Effective: May 2016

Document Number: 88-026729-01, Revision A



Trademark Information

The Programmable Logic Controller® and PLC® are registered trademarks of the Allen-Bradley Company (Rockwell Automation).

CoDeSys® is a registered trademark of 3S-Smart Software Solutions GmbH.

Windows® is a registered trademark of Microsoft® Corporation.

SD is a trademark or registered trademark of SD-3C, LLC in the United States, other countries or both.

Acronis® is a registered trademark of Acronis International GmbH.

Intel® is a trademark of Intel Corporation in the U.S. and/or other countries.

Important User Information

Please read and follow all safety information for the Interact Xpress Software, including the warning and caution statements in this guide, before installing or operating the system.

Safety Information



WARNING: Interact Xpress Software may be used to control electrical and mechanical components of motion control systems in industrial environments. To avoid serious injury or damage to equipment, test the motion system for safety under all potential conditions.



WARNING: Interact Xpress Software is not fault-tolerant and is not designed or intended for any use in any systems, machines, or applications where failure or fault of any kind of the Products could reasonably be seen to lead to death or serious bodily injury of any person, or to severe **physical or environmental damage (“High Risk Use”)**. You are not permitted to use, distribute, or sublicense the use of these Products in High Risk Use. High Risk Use is STRICTLY PROHIBITED.



WARNING: USER RESPONSIBILITY - Failure or improper selection or improper use of the products described herein or related items can cause death, personal injury and property damage.

CONTENTS

This document and other information from Parker-Hannifin Corporation, its subsidiaries and authorized distributors provide product or system options for further investigation by users having technical expertise.

The user, through its own analysis and testing, is solely responsible for making the final selection of the system and components and assuring that all performance, endurance, maintenance, safety and warning requirements of the application are met. The user must analyze all aspects of the application, follow applicable industry standards, and follow the information concerning the product in the current product catalog and in any other materials provided from Parker or its subsidiaries or authorized distributors.

To the extent that Parker or its subsidiaries or authorized distributors provide component or system options based upon data or specifications provided by the user, the user is responsible for determining that such data and specifications are suitable and sufficient for all applications and reasonably foreseeable uses of the components or systems.

Contents

Trademark Information	2
Important User Information	3
Safety Information	3
Contents	5
About This Guide	11
Assumptions of Technical Experience	11
Using this Guide	11
Documentation Library	13
Documentation Standards	13
Text Conventions	13
Notes, Cautions, and Warnings	14
CHAPTER 1: Requirements & Installation	15
System Requirements & Installation	16
Using Xpress with XT and XPR/XPR2 Powerstations	16
Xpress Manager System Requirements	16
Installing the Manager Software	17
CHAPTER 2: Product Overview	19
Brief Description	20
Development Tools	20
Runtime Operation	20
Networking and Web Publishing	21
Global Remote Support	21
Putting it All Together	21
The Xpress Manager	22
The Shell Environment	23
The Design Environment	24
The Runtime Environment	25
What is a Project?	26
What are Local and Remote Projects?	26
CHAPTER 3: Using Interact Xpress Manager	27
Overview of the Xpress Manager Interface	28
Using the Manager Workspace	28
Resizing the Workspace	30
Opening the Project	30
Saving the Project	31
Using the Local and Remote Panes	31
Viewing the Local and Remote Panes	31
Using the Local Pane	32
Selecting and Opening Projects	34

CONTENTS

Sorting Columns	34
User Administration Settings	34
Project Path	35
Using the Remote Pane.....	35
Selecting Projects	37
Sorting Columns	38
User Administrator Settings.....	38
Online Machines.....	38
Adding Machines	38
Using Removable Drives.....	40
Updating PowerStation Firmware Files	40
Updating Drivers	41
Transfer Buttons	42
Sending a Project	42
Send Project Validation	45
Get a Project	46
Get Project Validation	46
Status Bar	47
Project Recovery	47
Project Versioning	47
CHAPTER 4: Using the Shell Environment.....	49
Shell Environment	50
The Shell Window	50
Setting Security Options	52
Setting User Levels	53
Setting Up User Accounts.....	54
Using the Settings Menu	57
Setting General Options.....	58
Using the Online Editing Feature	59
Changing Project Settings.....	59
Setting the Time and Date	60
Calibrating Your Touchscreen.....	60
Configuring Network Settings	61
Configuring Email	63
Using the Import/Export Menu	63
Importing and Exporting Images.....	64
Importing and Exporting Tags and Alarm Definitions	65
Importing and Exporting Recipes and Message Tables	66
Importing and Exporting Project and System Languages.....	66
Using the Information Menu	66
Viewing System Resources.....	66
Viewing Versioning Information.....	67

Using the Utilities Menu	67
Viewing the Alarm Log	68
Viewing Currently Logged On Users	69
Viewing Response Times	69
Creating Reports	71
CHAPTER 5: Using the Design Environment	72
Using the Design Environment	73
The Design Environment	74
The Toolbar Icons	75
The Editor Tabs	76
The Workspace	76
The Menu	77
The Control Icons	78
Connection Status	79
Properties	80
Using the Panel Editor	80
The Panel Menu	81
Using the Color Picker	82
Selecting a Gradient	84
Inserting a Background Image	84
Deleting a Background Image	85
The Tool Box	85
Common Menu Commands	86
CHAPTER 6: Using the Tools	89
Using the Tools	90
Creating a New Project	90
Creating a New Panel	91
Adding Tools to a Panel	92
Testing the Panel in Run Mode	95
Adding More Panels	95
Testing the Panel with added tools in Run Mode	98
Testing the Panel with Numeric Entry and Display tools in Run Mode	100
Finishing your first Panel	100
Testing the Panel with Time/Date tools in Run Mode	102
Adding Tools to the Second Panel in your Project	102
Copying Tools between Panels	103
Testing the Tools2 Panel navigation buttons in Run Mode	104
Adding and Configuring the Slider, Gauge, and Bar Graph tools on the Tools2 Panel	104
Testing the Tools2 Analog Tools in Run Mode	105
Creating a New Panel with Message Tools	106
Testing the Message Tools in Run Mode	107
Adding a Message File and Message Tool to the Tools3 Panel	107

CONTENTS

Adding an Increment and Decrement button to the Tools3 Panel	109
Testing the Message Tools with a Message File in Run Mode	111
Creating a New Panel with Selection Entry and Recipe Tools.....	111
Manipulating Objects	117
CHAPTER 7: Working With Graphics	125
Working with Graphics	126
Creating a New Project	126
Creating a New Panel.....	127
Adding Navigation Tools to a Panel	128
CHAPTER 8: Using the Tag Editor	143
Using the Tag Editor	144
The Tag Editor Window.....	144
Data Transfers	145
Sorting Tags	146
Tag and Expression Icons	146
Creating and Editing Tags	147
The Edit Tag Screen	148
Deleting Tags	151
Validating Tags.....	151
Syntax Checking	151
Control Device Address Checking	152
Tag Initialization	152
Initial Data Transfers	152
Using System Tags	153
Using Expressions	162
Accessing Operators and Functions	162
General Information on Expressions.....	163
Available Functions and Operators	163
Expression Errors	168
Using Data Types	169
Tag Scaling.....	170
General Information on Scaling	170
Input/Write Scaling	170
Output/Read Scaling	171
Additional Scaling Information	171
Examples	171
Tag Rules	172
Local Tags	172
Xpress COMMServer Tags	174
CHAPTER 9: Using the Alarm Editor	177
Using the Alarm Editor.....	178

The Alarm Editor Display	178
The Alarm Editor Menu	179
Setting Up Alarm Properties	179
Creating Alarm Groups	180
Setting Alarm Priorities	182
Logging Alarm Events	184
Creating Alarms	184
The Alarm Viewer Tool	186
Creating Connections to Alarm Viewer Tool	189
CHAPTER 10: Using the Recipe Editor	190
Using the Recipe Editor	191
The Recipe Editor Display	191
The Recipe Menu	192
Creating Recipes	192
Adding and Editing a Recipe Item	193
The Recipe Viewer Tool	196
Creating Connections to the Recipe Viewer Tool	196
CHAPTER 11: Using the Message Editor	198
Using the Message Editor	199
Creating Message Tables	199
Adding and Editing a Message	200
CHAPTER 12: Working with Animation	201
Working with Animation	202
Types of Animation	202
Animating an Object	202
CHAPTER 13: Using the Runtime Environment	204
Using the Runtime Environment	205
The Runtime Environment	205
Customizing the Runtime Environment	205
Testing Your Project in Runtime	206
Entering Runtime	206
Exiting Run Mode	206
CHAPTER 14: Multiple Language Support	208
Multiple Language Support	209
Translating Interact Xpress Manager	209
Adding a Language	209
Switching a Language	209
Translating Designer and Shell	209
Adding a Language	209
Switching Designer and Shell Language	210

Remove a Language.....	210
Translating Runtime.....	210
Adding a Language.....	210
Working in Designer with the added Language(s).....	210
Switching the Runtime Language using a Language Button.....	211
Switching the Runtime Language using a System tag.....	211
Switching the Runtime Language using the Logged-In User.....	211
Remove a Project Language.....	211
Supported Languages.....	211
CHAPTER 15: Working with Communication Drivers.....	214
Working with Communication Drivers.....	215
Adding a Channel.....	215
To Add a Channel.....	216
Adding a Device.....	218

About This Guide

Thank you for purchasing our Interact Xpress (Interact Xpress Manager) Human-Machine Interface (HMI) product. Interact Xpress Manager is an embedded HMI platform with a distributed user interface. Interact Xpress employs a unique embedded client/server architecture providing a highly functional HMI solution that is extremely easy to configure and deploy.

Please take time to review this guide before configuring and designing your Interact Xpress Manager projects.

This installation guide is intended for those who are responsible for installing, configuring, and troubleshooting HMI and PC products and their associated software and accessories.

NOTE: Stay up-to-date with the latest version of this User Guide by downloading the most current copy from the web at http://www.parkermotion.com/products/Dedicated_HMI__7223__30_32_80_567_29.html.

Assumptions of Technical Experience

Parker Hannifin Corporation assumes you are qualified in the servicing of industrial control systems, and trained in recognizing hazards in products with hazardous energy levels. To install and troubleshoot XT/IX/PC Power Stations, you should have a fundamental understanding of the following:

- Electronic concepts such as voltage, current, and switches
- Grounding techniques, wiring, and separation of data conductors and power
- Networking and data communications

Using this Guide

This guide is designed to help you configure, design, and deploy your Interact Xpress Manager 4.1 projects. The guide describes all areas of the HMI interface including the configuration of tags, alarms, recipes, and message displays. Also included are tutorials to assist you in getting up and running in a short period of time.

This guide is divided into the following chapters:

- **Chapter 1 - System Requirements & Installation:** This chapter describes the minimum system requirements to use the Interact Xpress software. Also described are the system installation procedures and product licensing requirements.
- **Chapter 2 – Product Overview:** Provides an overview of the Interact Xpress product. Describes Interact Xpress Manager, Shell, Designer, and the Runtime interface.

- **Chapter 3 - Using Interact Xpress Manager:** This chapter describes the Interact Xpress Manager interface along with all the features and menus associated with it. Information in this chapter can also be found within the Interact Xpress Manager help system.
- **Chapter 4 - Using the Shell Environment:** Provides a complete description of the Shell interface. User Administration, configuring communication drivers, import/export features are just some of the topics discussed in this chapter.
- **Chapter 5 - Using the Design Environment:** Provides a description of all the common menus and dialogs available within the Interact Xpress Designer interface. Also provides a brief introduction to each of the editors such as the tag, alarm, and list editors.
- **Chapter 6 - Using the Tools:** This chapter provides a specification sheet for each tool object in Interact Xpress. These specification sheets describe all the properties and commands associated with a tool. Also included in this chapter is a tutorial that steps you through a simple project containing a couple of tools.
- **Chapter 7 - Working with Graphics:** This chapter provides a specification sheet for each graphical object in Interact Xpress. These specification sheets describe all the properties and commands associated with a graphic. Also included in this chapter is a tutorial that steps you through a simple project containing a couple graphic objects.
- **Chapter 8 - Using the Tag Editor:** Provides a complete description of the Tag Editor. Presented is information on system tags, how to create tags within the Tag Editor, the available functions and operators, and topics on scaling and tag validation rules.
- **Chapter 9 - Using the Alarm Editor:** Complete description of the Alarm Editor features and functions is provided. Alarm Editor menus and dialogs are described along with steps on how to create alarms within the editor.
- **Chapter 10 - Using the Recipe Editor:** This chapter describes all the menus and dialogs associated with the List Editor. Steps on how to create lists are provided.
- **Chapter 11 - Using the Message Editor:** Message Editor menus and dialogs are completely described within this chapter. Also included are steps to create, modify, print, and delete message files.
- **Chapter 12 - Working with Animation:** This chapter describes in detail the five types of animation connections that can be created and applied within Interact Xpress. Grouped animation is also discussed along with a tutorial that steps you through configuring each type of animation connection.
- **Chapter 13 - Using the Runtime Environment:** Provides an overview of the Interact Xpress runtime interface. Runtime error icons are described within this chapter.
- **Chapter 14 - Multiple Language Support:** Provides an overview of the Interact Xpress language support features and procedures.
- **Chapter 15 - Working with Communication Drivers:** This chapter provides configuration and overview information on Interact Xpress drivers. Each Interact Xpress driver has help information available and this chapter directs you where to access this information.

Documentation Library

The Interact Xpress documentation set contains all the information you need to configure, install, and use the Interact Xpress HMI product. The Interact Xpress documentation set is described below.

Interact Xpress User Guide - This is the document you are reading. It provides detailed information about the Interact Xpress product and describes how to configure, install, and deploy an Interact Xpress project. Most of the information contained in this guide can also be accessed through the online help system within Interact Xpress.

Interact Xpress Manager Help - Interact Xpress Manager has a complete help system to allow easy access to information specific to the Xpress Manager interface. This help system is also included in this guide, refer to chapter 4.

Interact Xpress Help - Interact Xpress help refers to the help system that resides on the Interact Xpress machine. This help is context sensitive, providing you information at the point where you most need it. The information contained within this help system is also within this guide in its entirety for your reference.

This user guide is for Interact Xpress version 4.1 and higher. Some features described in this user guide may not be available for versions 3.1 and lower.

Documentation Standards

As you read this guide, notice that it uses the following documentation standards:

Text Conventions

Style	Type of Text
Bold	Names of buttons, tabs, menus, menu items, commands, files, keyboard keys, dialog boxes and other important terms.
<i>Italic</i>	Titles of User Guides, chapters, or sections and cross-references.
Courier font	Text to be entered from a keyboard.
+	Indicates two or more keyboard keys that must be pressed simultaneously. For example, Ctrl+Alt+Delete .
Note	Alternative approaches or issues you should be aware of while using a particular function.
Important	Information that will save time and minimize problems.
Warning	Information that will prevent equipment damage or personal injury.

Notes, Cautions, and Warnings

This guide uses warnings, cautions, and notes throughout the text to draw your attention to information that is especially important or useful.



WARNING: A warning provides information about a potential for property damage, personal injury, or death.



CAUTION: A caution provides information intended to help prevent malfunction of the product or damage to the product hardware or software.

NOTE: A note provides information intended to help you make the best use of your product from Parker Hannifin Corporation.

CHAPTER 1: Requirements & Installation



System Requirements & Installation

This chapter lists requirements for the installation of both Interact Xpress and the Interact Xpress Manager software. Information regarding licensing your Interact Xpress installation is also presented.

Interact Xpress Manager is a Windows-based program for a desktop or laptop computer. It makes the development of HMI projects portable by allowing you to create and edit projects offline, and then deploy those projects to the Interact Xpress platforms.

Interact Xpress is an embedded HMI platform with a distributed user interface. Interact Xpress employs a unique embedded client/server architecture providing a highly functional HMI solution that is extremely easy to configure and deploy. Since the software is embedded within Interact Xpress workstations and machines there are no system installation requirements or installation procedures. Your Interact Xpress workstation or machine already comes with the software installed.

Using Xpress with XT and XPR/XPR2 Powerstations

XT PowerStations can only run Xpress 4.1 or higher projects created by Xpress Manager 4.1 or higher. XPR/XPR2 PowerStations can only run Xpress 3.1 or lower created by Xpress Manager 3.1 or lower. Xpress Manager 4.1 can open, edit, download and upload 3.1 or lower Xpress Projects, but they must not be upgraded if the projects still need to run on an XPR/XPR2. Xpress Manager 4.1 cannot create an Xpress 3.1 project.

Each computer is only allowed to run one instance of Xpress Manager. If you only need Xpress Manager to program XT PowerStations, only install version 4.1 or higher. If you only need to program XPR or XPR2 PowerStations, only install version 3.1. If you need to program both XT and XPR/XPR2 PowerStations on one computer, use version 4.1. But, be sure not to upgrade any projects to version 4.1 that are intended only for XPR/XPR2 PowerStations as they will not work and the older version will be lost.

Xpress Manager System Requirements

The following table lists the system requirements for installing the Interact Xpress Manager software:

Component	Minimum System Requirements
Processor	Pentium III 800 MHz
Operating System	Microsoft® Windows® 7 (32bit or 64bit)
Memory	1 GB RAM
Disk Space	150 MB free hard drive space
Display	1024 x 768 video resolution, 16-bit color
Networking (Project Deployment)	10 MB Ethernet network interface card
Additional Software	Microsoft Internet Explorer® 10.0 or higher

Installing the Manager Software

Complete the following instructions to install Interact Xpress Manager on your workstation

1. Insert the CD and the installation wizard launches. You may also double-click the *Setup.exe* file located on the CD within the Interact Xpress Manager folder.
2. The installation wizard launches.

Follow the directions provided by the installation wizard.

You can now design, create, and deploy Interact Xpress projects to Interact Xpress machines.

CHAPTER 2: Product Overview



Brief Description

Interact Xpress is a compact and economical Human-Machine Interface (HMI) solution that leverages the availability of the Internet and IP networks. Using an Internet connection or an internal LAN (or other IP-based network) and a web-browser, you can easily create, view, edit, and publish HMI applications from anywhere in the world.

Interact Xpress (Xpress) runs in a browser-based environment combining a rich, graphical runtime interface with HMI development tools. Xpress employs a client/server architecture providing a highly functional HMI solution that is extremely easy to configure and deploy.

Xpress offer the following features:

- Simple, yet powerful development tools
- Feature-rich runtime operation
- Advanced networking and Web publishing
- Global remote support

Development Tools

Xpress software offers an integrated development environment where you can design and edit applications on the Runtime system or on a Windows-based workstation. With Xpress, HMI applications can be served and edited remotely from any standard PC Web browser - in real time.

Development features include:

- Sophisticated graphics
- Easy, object-based development tools including: push buttons, numeric entry and displays, selection entry, bar graphs, meters, gauges, sliders, message displays, recipes, and more
- Drag and drop editing
- Integrated graphics library and preconfigured styles
- Ability to develop and save your own styles
- Complex graphic and animation development
- Alarm tool with automatic collection of historical data
- Integrated Tag, Alarm, List and Message editors

Runtime Operation

Xpress software is pre-installed and bundled with Parker's XT PowerStation hardware which is designed to optimize the performance, storage and connectivity features of Xpress HMI. The XT PowerStation is available with several different sizes of touchscreen displays and a full range of standard features such as removable storage, 2 USB ports, 2 RS-232 and RS-232/422/485 ports, and 2 Ethernet ports. For more information, refer to the *XT PowerStation Series User Guide*.

The Runtime interface contains a rich, graphical environment that runs sophisticated graphics, animations, and video to enhance the operator experience.

Networking and Web Publishing

Xpress provides industry-leading Web publishing and multi-client support in an affordable distributed HMI package. Supporting local or remote development, there are no version control issues or online development costs. Since Xpress applications are developed, edited, and run in a browser, you can easily publish upgrades and applications using a client/server approach to any global location with a Mobile device or an Internet connection and a Web browser.

Choose between point-to-point Ethernet connection, LAN connection, or Internet connection for access from virtually anywhere in the world, using only a Mobile device or standard Web browser on a desktop or laptop computer.

The diagram below shows a standard Web browser interfacing with the Xpress Shell located on the Xpress machine.

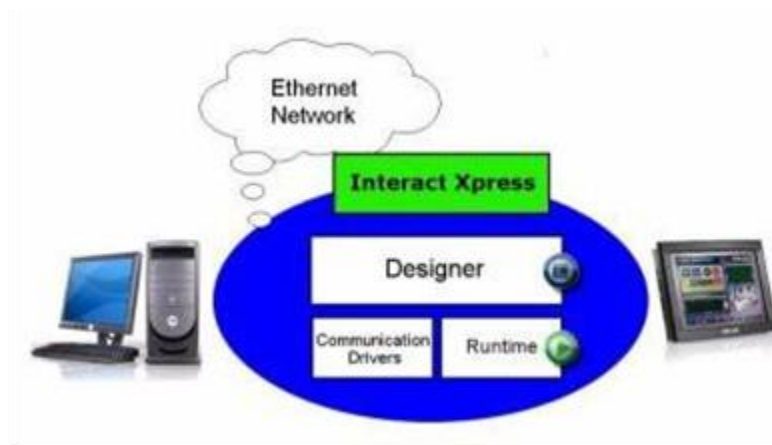

Global Remote Support

The most cost-effective way to support machinery installations or remote stations across geographical distances is through the Internet or other IP connections. Xpress makes it easier than ever to develop, edit, monitor, diagnose, share, and control machine applications online because it is just as capable of serving over an Ethernet connection, as it is to the local display.

This offers the benefit of optional remote access for HMI development, deployment, and execution with no additional cost, complexity, or effort.

Putting it All Together

At the heart of Interact Xpress lies an embedded server also known as the **Shell**, which houses the full-featured HMI Design and Runtime environments, as well as communication drivers for connecting to control devices. This core component provides the complete set of services for the creation, management, and runtime execution of operator interface projects.

To accomplish all of this, the Interact Xpress software is made up of the following components:

- **The Xpress Manager**

The Manager is what allows you to create and edit projects offline, as well as deploy them to Interact Xpress platforms. For more information on using the Xpress Manager, refer to *Using Interact Xpress Manager*.

- **The Shell Environment**

The Shell environment is where you setup your initial project, manage users, as well as change properties and settings as needed during development. For more information on using the Shell, refer to *Using the Shell Environment*.

- **The Design Environment**

The Design environment is where you build all of your message tables, lists and panels using tools, graphics, tags, and alarms. The bulk of your development is spent in the design environment. For more information on using the Designer, refer to *Using the Design Environment*.

- **The Runtime Environment**

The Runtime environment is where you test your project and simulate it running on the Xpress machine. For more information on using Runtime, refer to *Using the Runtime Environment*.

The Xpress Manager

Xpress Manager is a Windows-based program for a desktop or laptop computer. It makes the development of HMI projects portable by allowing for the creation and editing of projects offline, and deployment of the projects to Interact Xpress platforms. Xpress Manager (Manager) includes an Interact Xpress emulator which is used for editing and testing HMI projects, therefore replicating what you would see on the Interact Xpress machine.

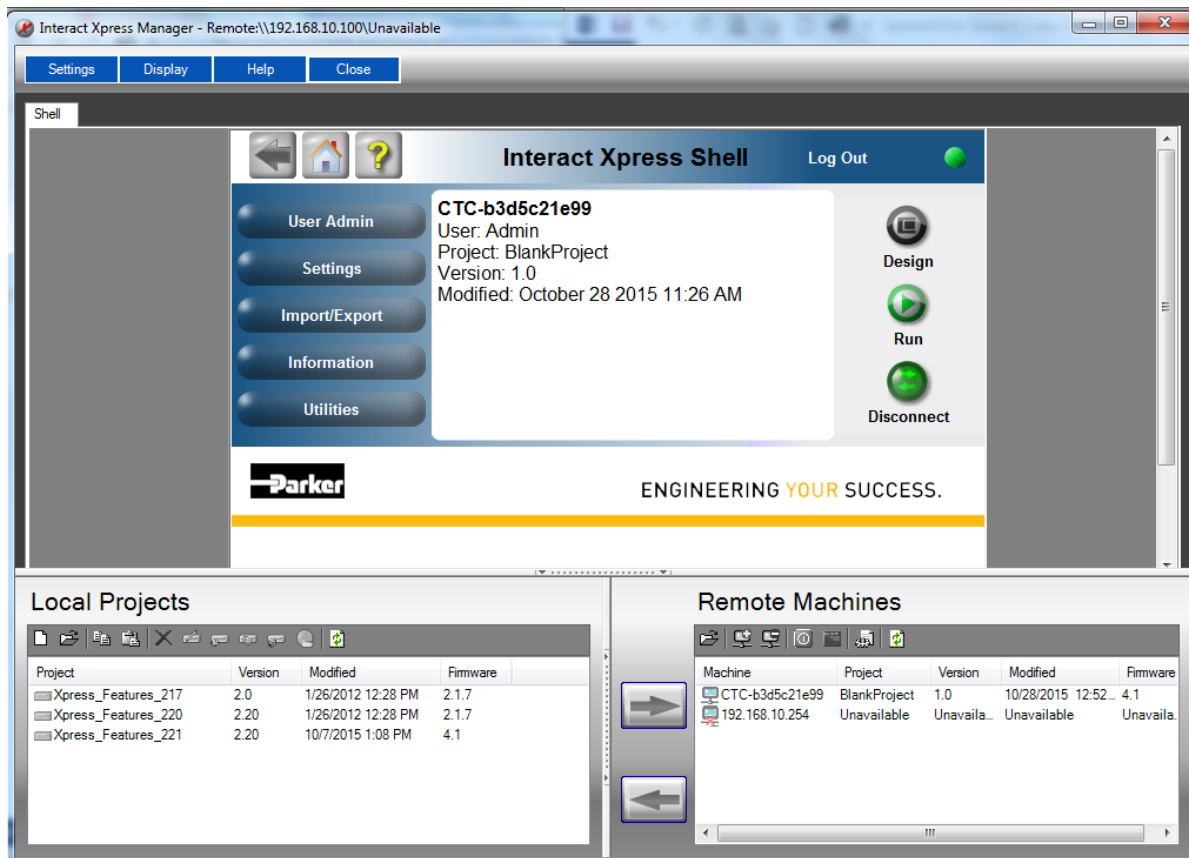

The Manager functions as an HMI project editing, deployment, and distributed maintenance environment. The Manager can connect directly to remote machines for editing projects online, sending or getting projects to and from the machine, or updating the machine system files. It has many features that make it easy to maintain and manage multiple local or remote Interact Xpress installations.

All project data is kept in a single file on your personal computer, making it extremely easy to back up, archive, or exchange projects with other users via email, network, or removable storage.

The Manager is an optional application as you can design HMI projects directly on the Interact Xpress machine or through a remote browser. Using the Manager does provide you with the ability to manage multiple Interact Xpress projects within a single application.

Refer to *Using Interact Xpress Manager*, for a complete description of the features and functions associated with the Manager.

The Shell Environment

The Interact Xpress Shell is a software program that runs on the Xpress machine. Each time you enter Interact Xpress or open a project in Interact Xpress Manager, the Shell window is displayed as shown below.

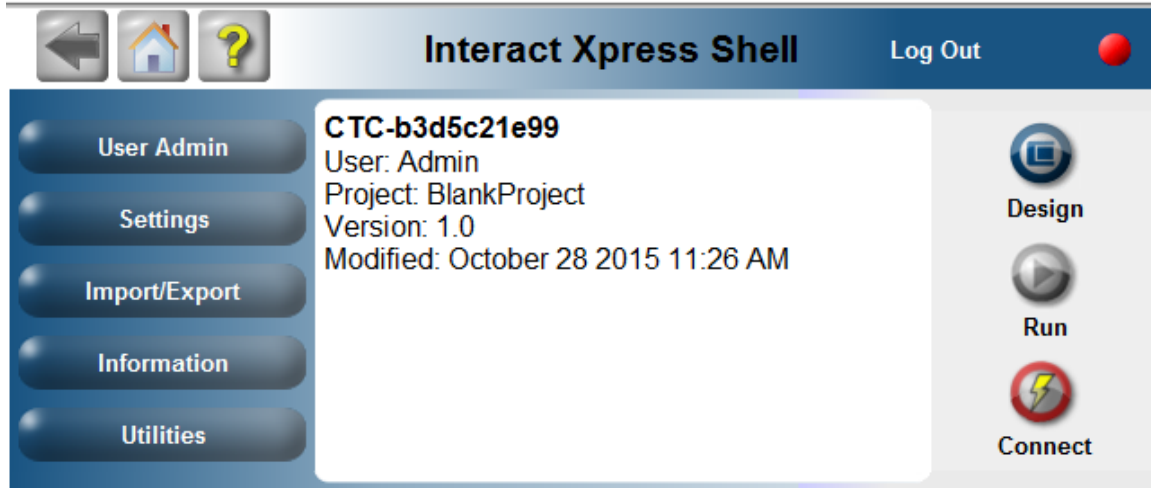

ENGINEERING YOUR SUCCESS.

The Shell environment is used for a variety of machine configuration operations. You can also use the Designer and Runtime environments from the Shell interface. Some of the tasks the Shell performs are listed below

- configure user administration settings
- launch utilities such as the touchscreen calibration utility
- import and export files into and out of the machine

For detailed information on working in the Shell, refer to *Using the Shell Environment*.

The Design Environment

Once you have setup and created your project, you are ready to design all of the components of your application. All HMI panels are developed in the Interact Xpress design environment.

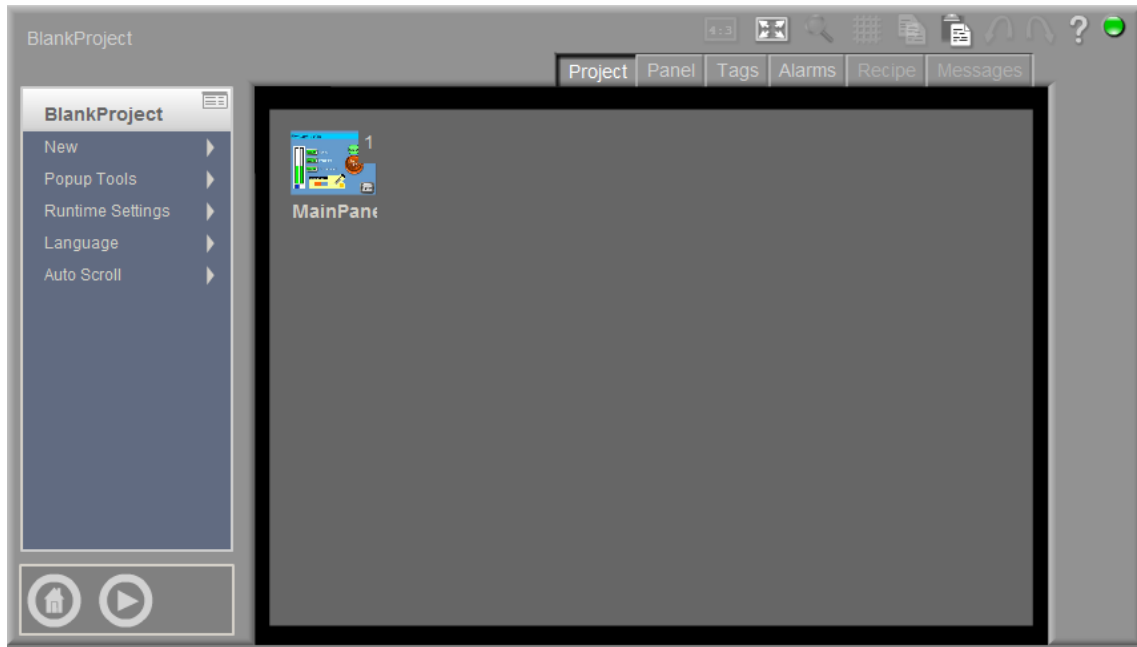

The Designer is where you build all of your panels, message tables, and lists. The bulk of your development is spent in the design environment. From the Designer, you can access the following editors.

- Project Editor
- Panel Editor
- Tag Editor
- Recipe Editor
- Alarm Editor
- Message Editor

Refer to *Using the Design Environment*, for a complete discussion of all the functions and features of the Designer.

The Runtime Environment

The Runtime environment refers to the software environment that lets you run your project. Runtime mode includes the ability to display and interact with panels, monitor real-time and historical alarms, communicate with the built in drivers, and serve tags to clients.

The server residing on the Interact Xpress box is the run mode component that drives your project. Your project can reside on a local PC, such as in offline development mode and remote access mode, or it can reside on the Interact Xpress box itself as in normal run mode operation.

Refer to *Using the Runtime Environment*, for a complete discussion of the Runtime environment.

What is a Project?

An Interact Xpress project is composed of the following components

- Panel configuration
- Tool assignments
- Tag configuration
- Message and Recipe configuration
- Alarm configuration
- Shell settings
- Communication and driver configurations

Xpress Manager supports the development of multiple projects. Xpress machines support one active project only. Therefore, using the Manager software, you can develop many projects for use with many different applications.

Projects are sent to the Xpress machine through the project transfer capabilities within the Xpress Manager software. However, you can also get projects off the Xpress machine. Projects cannot be manually added to Interact Xpress machines.

Projects are maintained as a single file with a **.lrp** extension. This makes it easy to transfer to the Interact Xpress Manager machine. The individual project files will then be extracted from the **.lrp** file once successfully transferred to the machine. With the project existing as a single file, it is easy to back up, archive, or exchange projects with other users via email, network, or removable storage.

Note: For project tracking purposes, each project may be tagged with a custom version number. This is described in detail in Project Versioning and Compatibility.

What are Local and Remote Projects?

Interact Xpress Manager uses the terms local and remote to differentiate between where Xpress projects are located.

A local project is one that is stored on the development workstation where the Interact Xpress Manager software is installed. A remote project is one that is stored on an Interact Xpress machine that is connected to the development workstation. The Xpress Manager software has the capability to work with projects that are either local or remote.

Sections of the Xpress Shell may be grayed out because they access controls that are only meaningful in the local context (such as touchscreen calibration).

For more complete information on working with local and remote projects, refer to *Using the Local and Remote Panes*.

CHAPTER 3:
Using Interact Xpress Manager



Overview of the Xpress Manager Interface

Xpress Manager is a Windows-based program for a desktop or laptop computer. It makes the development of HMI projects portable by allowing for the creation and editing of projects offline, and deployment of the projects to Interact Xpress platforms. Xpress Manager (Manager) includes an Interact Xpress emulator which is used for editing and testing HMI projects, therefore replicating what you would see on the Interact Xpress machine

The Manager functions as an HMI project editing, deployment, and distributed maintenance environment. The Manager can connect directly to remote machines for editing projects online, sending or getting projects to and from the machine, or updating the machine system files. It has many features that make it easy to maintain and manage multiple local or remote Interact Xpress installations.

All project data is kept in a single file on your personal computer, making it extremely easy to back up, archive, or exchange projects with other users via email, network, or removable storage.

Using the Manager Workspace

Interact Xpress allows you to develop projects on a local workstation for later transfer to remote machines. Interact Xpress Manager can also connect directly to a remote machine, open the remote project, and edit the project all while connected to the remote machine.

The Manager workspace is an integrated browser that is used for editing and running projects in a local Manager display. The workspace emulates what would be seen on an actual Xpress workstation.

With no project loaded a welcome screen appears in the workspace as shown below.

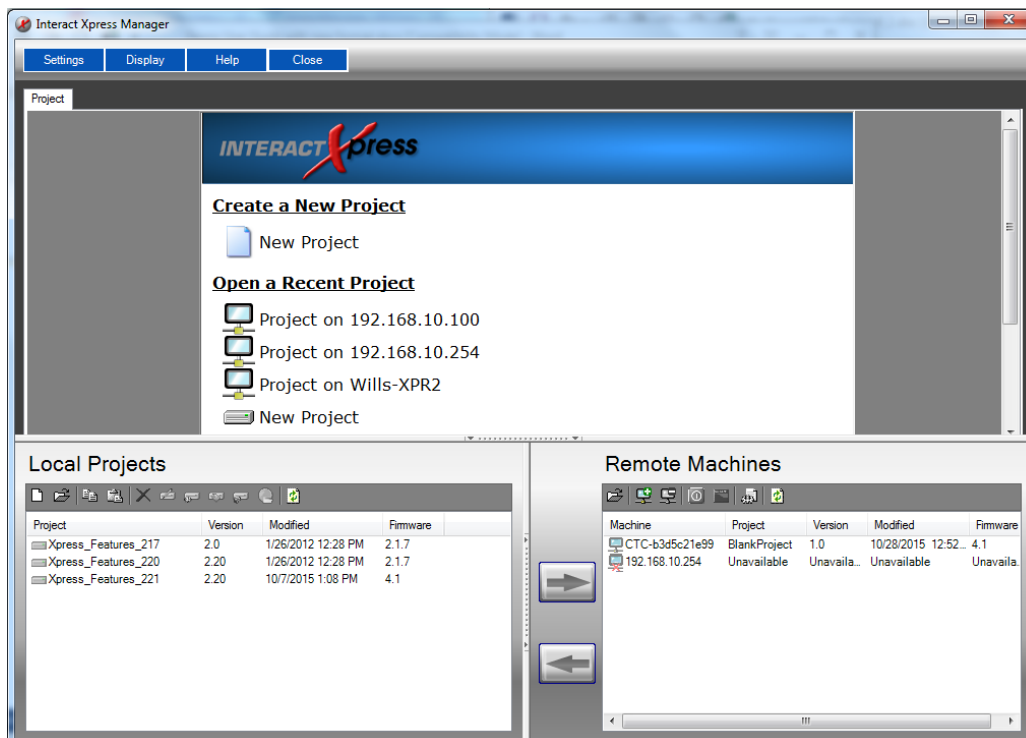

Before creating a project, you should become familiar with the Xpress Manager window:

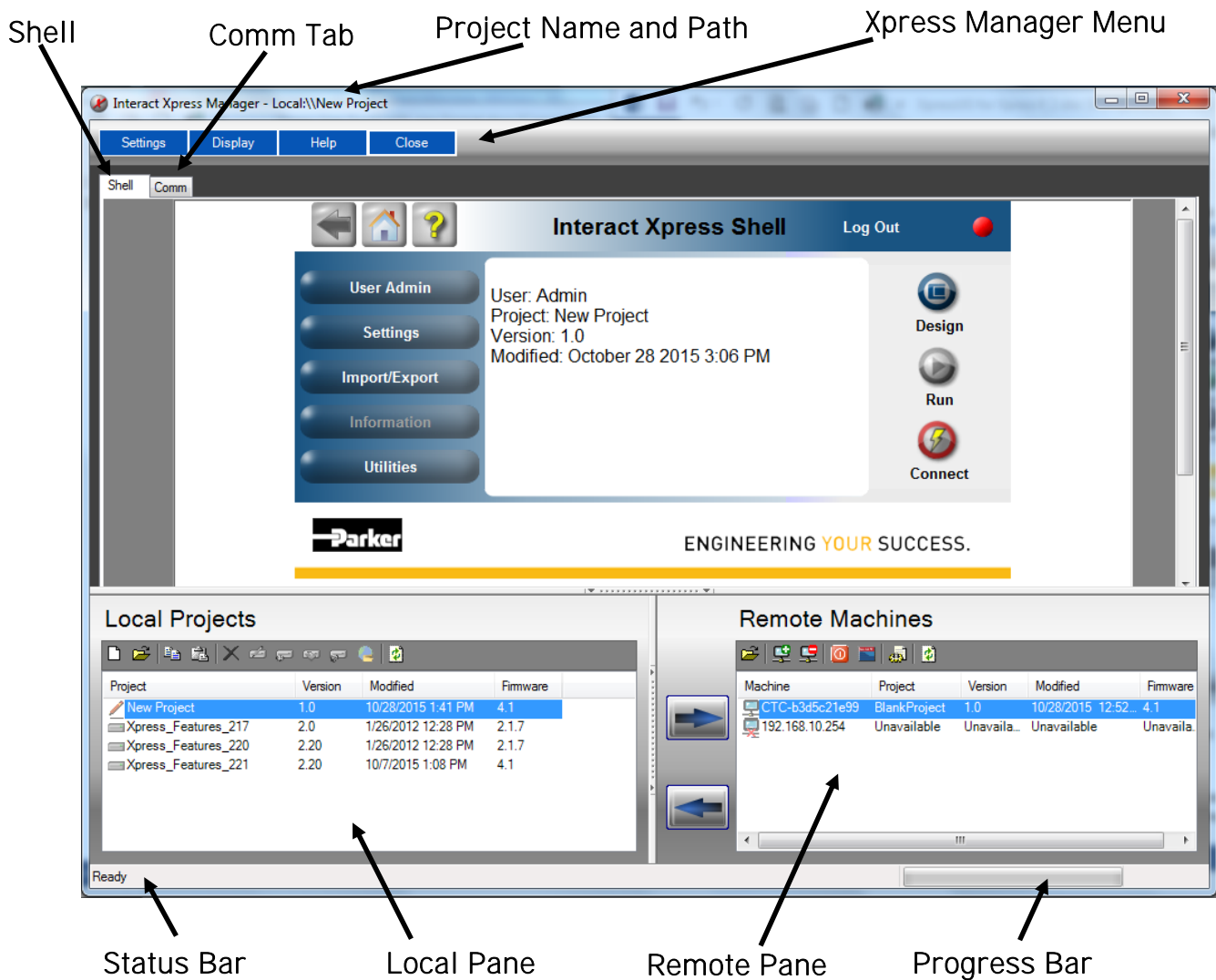

With a project loaded in the Shell workspace, the name of the project preceded by either **Local:** or **Remote:** is displayed in the upper left corner of the Manager window.

When a project loads, the Shell environment is displayed. If the project is a local project, then your user rights are set to Administrator. If the project is a remote project, then your user rights are determined by the Xpress machine. For more information on user administration, refer to *Using the Shell Environment*.

The Manager window contains the following components:

- The Menu

The menu allows you to select your display size, whether you want to be prompted to upgrade your software, access help information and close a project or exit out of the Xpress Manager software.

- **The Shell Tab**

The Shell tab (or environment) is displayed after opening a local or remote project, and is an integrated browser that is used for editing and running projects on a local computer. The Shell workspace emulates what would be seen on an actual Interact Xpress workstation. The Shell is where you initially setup your project, manage users, and change properties and settings as needed during development.

- **The COMM Tab**

The COMM tab is displayed once a *local* project is open. A local project is an application currently in development and resides on your local computer. Use the COMM tab to add channels and devices to your project.

- **The Project Tab**

The project tab is displayed only when choosing a project to open. You can either create a new project or open a recently viewed project.

- **The Local Pane**

The Local Pane lists all of the Xpress projects that currently reside on the local workstation. If the project is a local project then your user rights are set to Administrator. For more information on users refer to the Interact Xpress User Guide.

- **The Remote Pane**

The Remote Pane lists all of the Xpress machines that are accessible from your local workstation and the corresponding projects that are currently running.

- **The Status Bar**

The status bar, located on the bottom of the Manager window, is used to display any messages from the Xpress Manager.

Resizing the Workspace

The workspace may be resized, enabling you to observe the size of the screen and how it should appear on the Interact Xpress machine.

To change the size of the workspace, select one of three menu items: **Display: Small, Medium, or Large** from the Manager menu.

Opening the Project

When you open or load a project, the Manager copies the project from the project folder into a temporary folder for editing purposes. The file in the temporary folder is then loaded into the Shell.

To open a project, highlight the desired project in the local or remote pane and double-click on it. You can also choose the project from the welcome screen under –Open a Recent Project.

You can only open one project at a time per instance of the Xpress Manager software. Opening another instance of the Manager allows you to open a second project if desired.

If the project was created in an earlier version of the Xpress Manager, and the Prompt to Upgrade option is selected, then the Upgrade Project dialog is displayed. Select Upgrade Now to upgrade the project or Do Not Upgrade to leave the project in its current version. The project is opened in the browser with the Shell main page displayed.

If the Prompt to Upgrade option is not selected, the project is opened in the browser with the Shell main page displayed.

Saving the Project

To close and save a project, select the **Close: Close Project**, from the Manager menu. Closing a project moves your project file from the temporary folder and saves it in the project folder. After closing the project, the welcome screen is displayed.

Using the Local and Remote Panes

The lower section of the Manager Workspace includes two panes. The left pane is used to display local project information while the right pane is used to display information concerning a remote Interact Xpress machine or removable drive.

The left pane is referred to as the local pane while the right pane is referred to as the remote pane.

Projects located on the local system appear in the local pane. For the remote pane, the Manager detects remote machines and populates the remote pane with those machines. The Machine Name or IP address of the machine is displayed in the remote pane.

Viewing the Local and Remote Panes

You can adjust the lower section of the Manager window by moving the divider that separates the workspace from the local/remote pane area. This provides more space to work with your panels.

To hide or display the Local and Remote panes in the Xpress Manager window, click on the horizontal divider as shown below. This expands (or collapses) the window. You can also expand or collapse the Remote pane by clicking on the vertical divider.

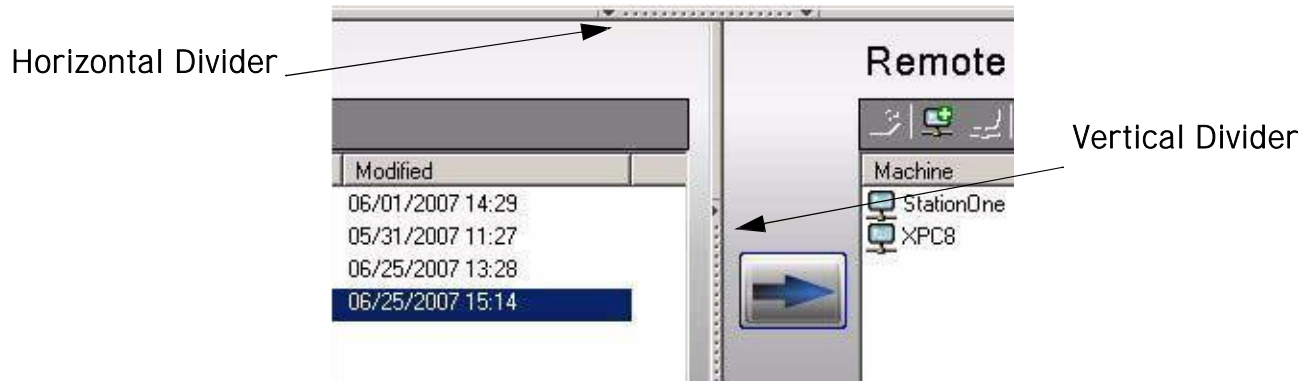

Using the Local Pane

The local pane displays a list of all of the Xpress projects that currently reside on the local computer. The project list contains information such as the project name, version, and last modified date. The list of projects appears in alphabetical order as shown below.

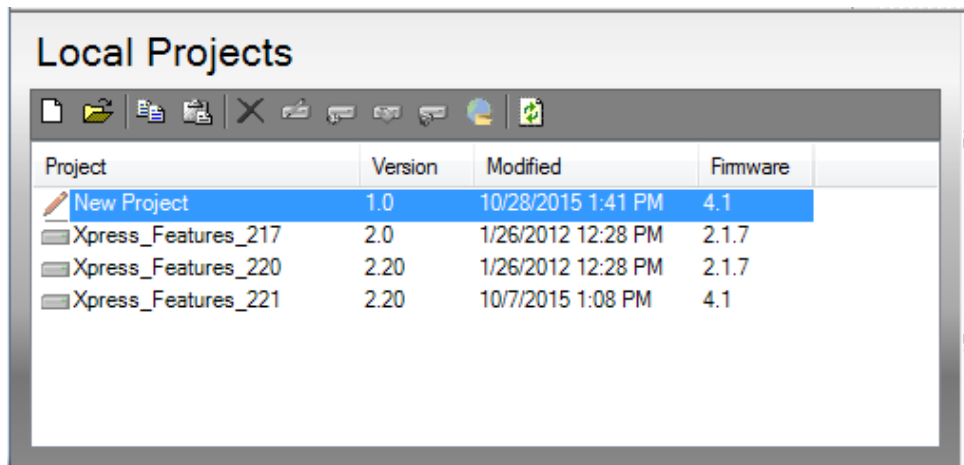











In the project list, the project column displays the name of the project that resides on the local workstation. The version column displays the version of the project. Finally, the modified column lists the date and time the project was last modified.

The local pane displays a "pencil" icon next to the project that is loaded. This indicates the project is currently being edited.

Icons displayed at the top of the pane are also available from the Local Pane menu. To access the menu, right-click on the Local Pane. The menu options are described in Table 4-1, below.

Table 4-1: Local Pane Menu Commands

Icon	Menu Option	Definition
	New	<p>Creates a new project. Enter the project name in the New Project dialog box. The name must be alphanumeric and is limited to 64 characters. Special characters such as underscores and dashes are not allowed.</p> <p>The default path to where the project is located on the local machine is: C:\Users\YourUserName\Documents\Parker</p> <p>The project path is setup during installation.</p>
	Open	<p>Opens a project in the Shell. Highlight the project you want to open and use the icon or menu option to open it. You can also double-click a project within the local pane and it launches within the browser.</p> <p>Opening a project created in an earlier version of the Xpress Manager will display a prompt if the Prompt to Upgrade option is selected in the Settings menu.</p> <p>Open projects are displayed with a pencil icon next to the project name.</p> <p>Once a project is opened, if you try to copy, delete, rename, or send the project, a prompt appears stating that you will need to close the project in order to continue with the operation.</p> <p>If another project is already open in the browser, you are prompted to close the project before opening the newly selected project.</p>
	Copy	<p>Use the Copy command to copy a project then paste it into the local pane. Copying and pasting of projects works just like Windows Explorer.</p> <p>If no project is selected, the Copy icon is grayed out.</p>
	Paste	<p>Use the Paste command to paste the copied project into the local pane. Pasting a project automatically renames it to <project_name>(1).</p>
	Delete	<p>Use the Delete command to remove the selected project. Only one project at a time can be deleted. Deleting a project removes the project .Irp file from the projects directory on the local machine.</p>
	Rename	<p>Use the Rename command to rename the selected project in the pane. Enter the new name for the project in the text box.</p>

	<p>Modify Version</p>	<p>Use the Modify Version command to change the version number of the selected project. This allows you to keep track of any changes made to the project, if desired.</p> <p>The version number of a project is a two digit number. The first digit represents the major release of the Interact Xpress Manager software (and cannot be changed), while the second digit represents the unique number assigned to the selected project.</p> <p>Use the scroll box to change the second digit of the version number. The maximum number that can be entered is 100.</p>
	<p>Upgrade Project</p>	<p>Use the Upgrade Project command to select a project to upgrade for use with the latest version of Interact Xpress Manager.</p>
	<p>Compact Project</p>	<p>Use the Compact Project command to reduce the project to its minimum physical size.</p>
	<p>Import Web Content</p>	<p>Use the Import Web Content command to add htm, html, pdf, txt, doc, xls, swf and jpg files to be used by the Web Link Button.</p>
	<p>Refresh</p>	<p>Use the Refresh command to reload the local pane with the current list of projects.</p>

Selecting and Opening Projects

Select a project by clicking on a project within the pane. Open the project by selecting the Open icon; the highlighted project is launched in the browser. You can also open a project by double-clicking on the project name within the Local Pane.

When you open or load a project, the Manager copies the project from the project folder into a temporary folder for editing purposes. The file in the temporary folder is then loaded into the Shell.

To open a project, highlight the desired project in the local or remote pane and double-click on it. You can also choose the project from the welcome screen under –Open a Recent Project.

Sorting Columns

You can sort the columns in the local pane by clicking on the column header you want to sort. Interact Xpress Manager defaults to sorting the local pane alphabetically then numerically by project name.

User Administration Settings

Through the Shell, a project is configured with user administration settings. These user settings determine the editing and viewing rights of each user of the project. For a complete description of User's and User Levels, refer to *Using the Shell Environment*.

Working with local projects in Interact Xpress Manager bypasses all of the user administration settings. Therefore, you never have to logon to a local project.

Each time a local project loads, it starts up in the Shell with administrator rights. It does not matter what the user administration settings configured for the project actually are.

Once the project is loaded in the workspace and you enter the Designer, the project then follows the specified user administration settings. Once in the Designer, you can then test the project, which behaves like it would normally on the remote machine. If the project is closed down and then reopened, it opens in the Shell with Administrator rights again.

Project Path

The default project path is determined by the Manager installation path. By default, all projects on the local workstation are saved to the following directory:

C:\Users\YourUserName\Documents\Parker

Change the project path by selecting **Settings: Local Project Path** from the Manager menu. You can change the path to edit a project that is located on a removable drive or a network drive.

Using the Remote Pane

The remote pane consists of a project list, icons and menu commands, and project transfer buttons. The project list contains information such as the machine name, project name, version, and last modified date. The list of machine names are displayed in alpha-numeric order.

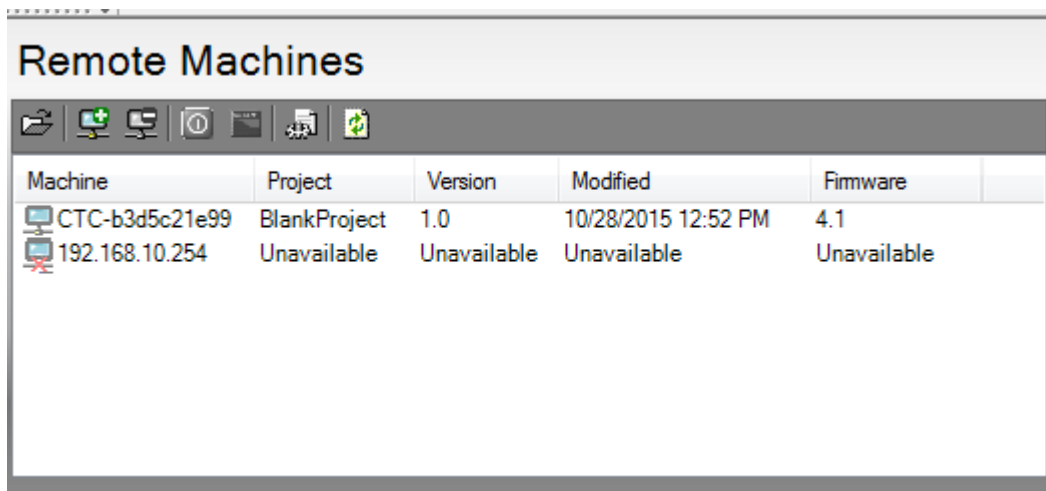







Machine	Project	Version	Modified	Firmware
CTC-b3d5c21e99	BlankProject	1.0	10/28/2015 12:52 PM	4.1
192.168.10.254	Unavailable	Unavailable	Unavailable	Unavailable

In the project list, the machine name column displays the machine name or IP address of the Interact Xpress Manager machine as it was configured in the Shell of that machine. The project column displays the name of the project that resides on the remote machine. The version column displays the version of the project. The modified column lists the date and time the project was last modified. Finally, the Firmware column displays the Xpress firmware version of that project.

Icons displayed at the top of the pane are also available from the Remote Pane menu. To access the menu, right-click on the Local Pane. The menu options are described in Table 4-2, below.

Table 4-2: Remote Pane Menu Commands

Icon	Menu Option	Definition
	Open	<p>Opens a project in the Shell. Highlight the project you want to open and use the icon or menu option to open it. You can also double-click a project within the local pane and it launches within the browser.</p> <p>Before opening the project, Interact Xpress Manager checks to see if the selected machine is set to require a logon or not. If a logon is required, then you must enter a user name and password in order to open the project.</p> <p>Open projects are displayed with a pencil icon next to the project name.</p> <p>Once a project is opened, if you try to copy, delete, rename, or send the project, a prompt appears stating that you will need to close the project in order to continue with the operation.</p> <p>If another project is already open in the browser, you are prompted to</p>
	Add Machine	<p>Use the Add Machine command to manually add a machine to the remote pane. Enter either the machine IP address or the machine name in the Add Machine dialog box.</p>
	Remove Machine	<p>Use the Remove Machine command to remove the selected machine from the Remote pane. Only one machine at a time can be removed.</p> <p>You cannot use this command on a movable drive such as an SD Card or Compact Flash (CF) drive. Therefore, the Remove Machine button is disabled if a SD or CF drive was selected.</p> <p>For machines that are automatically detected by the network, if you remove the machine, then refresh the screen, the removed machine reappears in the remote list if it is still online.</p>

	Restart Machine	<p>Use the Restart Machine command to reboot the selected remote machine using the Manager.</p> <p>Before restarting the remote machine, Xpress checks for a logon requirement. If a logon is required, enter the user name and password in the dialog box.</p> <p>When the reboot is initiated, the machine being rebooted sends out a message to all remote machines that are connected. The message informs the remote users that a particular machine is being updated and they should try to logon again in a few minutes.</p> <p>Restarting a machine causes a project on the Xpress machine to enter lock out mode. Restarting the machine also checks the –Edit Project" permission of that user. If the logon user has the correct permissions, the Manager then sends a command to reboot the machine.</p> <p>After a successful reboot, remote users are able to reconnect to the project.</p> <p>Removable drives such as SD or CF drives have the Restart Machine option disabled.</p>
	Update PowerStation Firmware	<p>Use the Update PowerStation Firmware command to update the highlighted Xpress machine with the latest system file.</p>
	Update Drivers	<p>Use the Update Drivers command to update the drivers on the highlighted remote machine. A list of drivers currently installed on the local machine is displayed in the Update Drivers dialog box. For more information, refer to <i>Updating Drivers</i>.</p>
	Refresh	<p>Use the Refresh command to rebroadcast on the network for available online machines.</p> <p>A machine icon indicates a machine was found and is online. An X indicates the machine cannot be found.</p>

Selecting Projects

Select a project by clicking on a project within the pane. Open the project by selecting the Open button and the project is launched in the browser. You can also open a project by double-clicking on the project name within the pane. If a machine is not online, the Open button is grayed out.

The remote pane displays a pencil icon next to the project that is loaded. This indicates the project is being edited.

The remote pane is populated based on the Manager software automatically locating the Xpress machine on the network as soon as it boots up. Any Xpress machines that are found on the network display within the remote pane. It is possible to manually add a machine if the machine has not appeared dynamically, refer to *Adding Machines*.

Working with the remote project in the Shell environment allows access to all options just as if you were working on the local machine. Sections of the Interact Xpress Shell may be grayed out because they access controls that are only meaningful in the local context (such as touchscreen calibration).

Sorting Columns

The columns are sorted by selecting a column header. Interact Xpress Manager defaults to sorting the remote pane alpha-numerically by machine name.

User Administrator Settings

Working with remote projects applies all of the user administration logon and password settings configured in the Shell.

Each time you choose to either Open, Send, or Get the project, or Upgrade the system file, Interact Xpress Manager checks to see if that machine is set to require a logon.

If the machine requires a logon, a logon dialog appears. The dialog has a checkbox to remember the user name and password. If checked, you are automatically logged on the next logon attempt and you are not prompted.

The password and user name are only persisted for the current Interact Xpress Manager session. As soon as the Manager exits, all persisted passwords are removed. However, if the password or user name are changed, you are prompted again.

Online Machines

The Remote Pane detects all machines on the network. Once detected, the machine displays an icon indicating whether it is connected or not connected. Selecting a particular machine in the remote pane lists a message in the status area indicating whether the machine is connected (online) or disconnected (offline).

Right-clicking on a project in the remote pane displays several options depending whether a machine is online or offline. Machines that are offline have the Open, Update System File, and Restart Machine options grayed out.

Adding Machines

The Remote Pane is populated with machines that have been automatically detected as well as manually added. The remote pane displays a mix of machine names and IP addresses depending on how the machine was added to the list.

When a machine is manually added it persists even after the Interact Xpress Manager software is shut down and restarted. However, if the Manager is not physically connected to the network, the list of manually added machines are not present.

You can use the Add Machine dialog box, shown below, to add a remote Xpress machine. To open this dialog box, click on the Add Machine icon or use the Remote pane menu command. You can add a machine using its IP address or its machine name.



To add a machine using its IP address, select the IP Address radio button and enter the IP address in the box below it. To use the machine name, select the Machine Name radio button and enter the name of the remote machine or select the "..." button to browse for its location on the network.

When manually adding a machine using the IP address of the machine, the remote pane displays the machine name if it is connected. If the machine is not connected, then the IP address appears in the list.

If you add two machines, one using the IP address and the other using the name, and they happen to be the same machine, both of them display using the machine name. One of these added machines displays a warning icon and a message in the status area indicating that it's a duplicate.

The Interact Xpress Port number is the machine network port used to communicate between the Manager and the machine. The port defaults to number 1235. You may need to change this number if there is a service already using this port or if there is a system firewall between the Manager and the machine. Contact your network administrator for a valid number to enter in this field.

If the machine you are adding is known to be on your network but does not appear in the Add Machine dialog list when you select the Find button, then you may need to assign a different Interact Xpress Port number.

If Interact Xpress Manager finds the manually added machine, then finds the same machine through the network auto-broadcast process, then only the manually added machine appears in the list. The auto-broadcast process occurs each time Interact Xpress Manager is launched.

Using Removable Drives

Removable drives are detected and displayed within the remote pane. Interact Xpress Manager allows sending and getting projects from removable drives such as SD or Compact Flash (CF) drives. Removable drives appear with the drive icon  G:\ shown in the pane.

If the removable drive does not contain a project, then the drive is displayed without a project name next to it. A removable drive cannot be deleted from the remote pane.

For the SD or CF to be able to run an Interact Xpress Manager project, the SD or CF must contain a system file that is compatible with the particular Interact Xpress Manager machine in which the SD or CF resides as well as being compatible with the project that you send to the machine.

If the SD or CF is not properly set up for the Interact Xpress Manager machine, Interact Xpress Manager displays a prompt that the selected media does not contain a valid system file. Installing a system file will erase all existing files on the SD or CF.

Use Interact Xpress Manager to send the system file to the SD or CF if it detects that the media has a proper Interact Xpress Manager image on it. Refer to the Update System Files section for more information on installing a system file.

After a compatible system file is installed on the SD or CF, then the project can be sent to the machine.

Updating PowerStation Firmware Files

Selecting the Update PowerStation Firmware button allows you to update the Interact Xpress software on a remote machine. The Manager automatically filters out the system files and only displays the files compatible with the hardware in the remote machine. Select the system file you want to send to the remote machine from the **System** drop down box.

Select the remote machine you want to send the file to from the **Send System To** drop down box. Enter a Username and Password to log on to the remote machine as a user before sending the file. You can also attempt to connect to the remote machine using the default Remote User Startup login on the target machine by checking the box in the middle of the screen.

Select the **Send** button to begin the file transfer. A confirmation message is displayed. Click **OK** to start the update process or **Cancel** to cancel out of the dialog box.

Note: The system file consists of all files that are not specific to the project file, this includes: OS files, COMM server files, swf files, hmi files, and help files. The system file is the NK.BIN file. It is not possible to transfer a system file from the remote machine to the local machine.

Once you have selected the **OK** button, the Xpress Manager goes through a validation process before sending the system file to the remote machine.

1. First, the Manager checks to see if it is compatible with the remote machine and able to perform the file transfer. If the local machine is not compatible, a message is displayed.

2. If the local machine is compatible and can connect to the remote machine, the Manager checks to see if the remote machine is in a lock out mode. If it is locked out, a message is displayed.
3. If the remote machine is not already in lock out mode, the Manager puts the remote machine in lockout mode and the new system file is sent. The old system file is deleted and is replaced with the new system file. Note that the *project* file is not deleted. The remote machine is then rebooted. A progress bar is displayed during the update of the system file.

Updating Drivers

You can update the drivers on a remote machine using Interact Xpress Manager. From the **Send Drivers To**, drop down list, select the remote machine where you want to send the .dll file(s). The default machine is the last one selected.

Enter a Username and Password to log on to the remote machine as a user before sending the driver files. You can also attempt to connect to the remote machine using the default Remote User Startup login on the target machine by checking the box in the middle of the screen.

A list of drivers currently installed on the local machine is displayed in the scroll box as shown below.

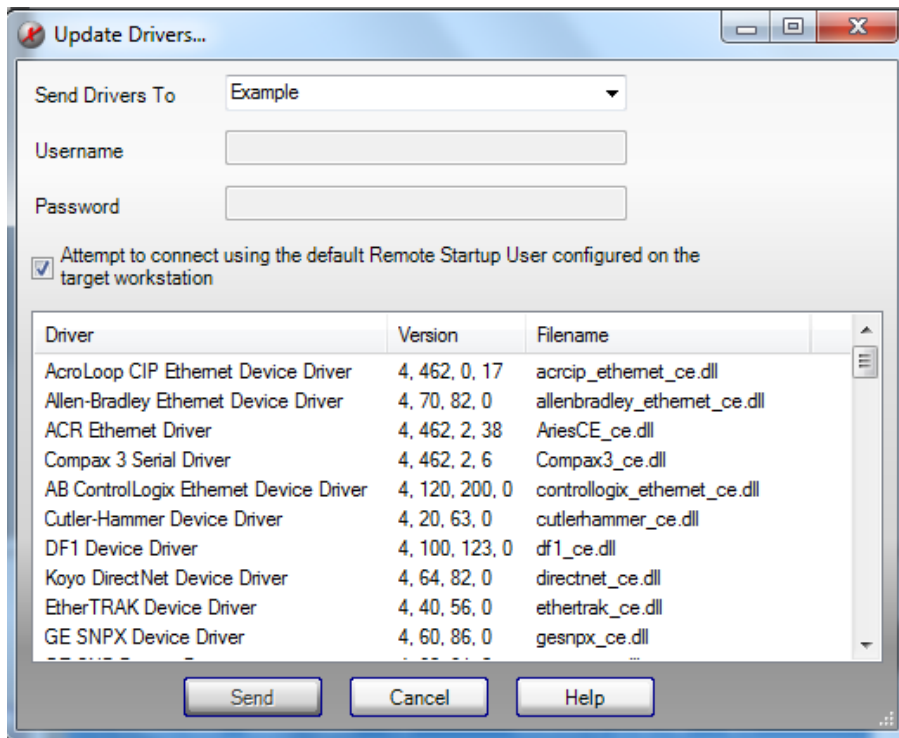

Click on the driver you want to send to the remote machine. To select multiple drivers, hold down the CTRL button and select the desired drivers. To select a series of drivers, select the first driver and hold down the SHIFT button, then select the last driver in the series, all drivers in between are also selected.

Select the **Send** button to send the highlighted driver files to the remote machine.

Transfer Buttons

There are three types of transfers that can take place between the Interact Xpress Manager workstation and remote Interact Xpress Manager machines.

- Send Projects
- Get Projects
- Update System File

During any project transfer, a progress bar, located below the remote pane, is displayed. When a transfer is initiated, a message displays in the status area indicating the current activity.

If Interact Xpress Manager can connect to the remote machine, then the transfer process begins.

If Interact Xpress Manager cannot connect within 30 seconds a message displays informing you to retry.

Sending a Project

The Send button is used to transfer a copy of a project from the local machine to the selected remote machine or a removable drive. This is also known as replicating a project.

The remote machine goes into a lock down condition for this process and the remote user is prompted about the lock down. While in a lock down condition, no edits can be made to the project.

When sending a project, the Send Project dialog box is displayed as shown below.

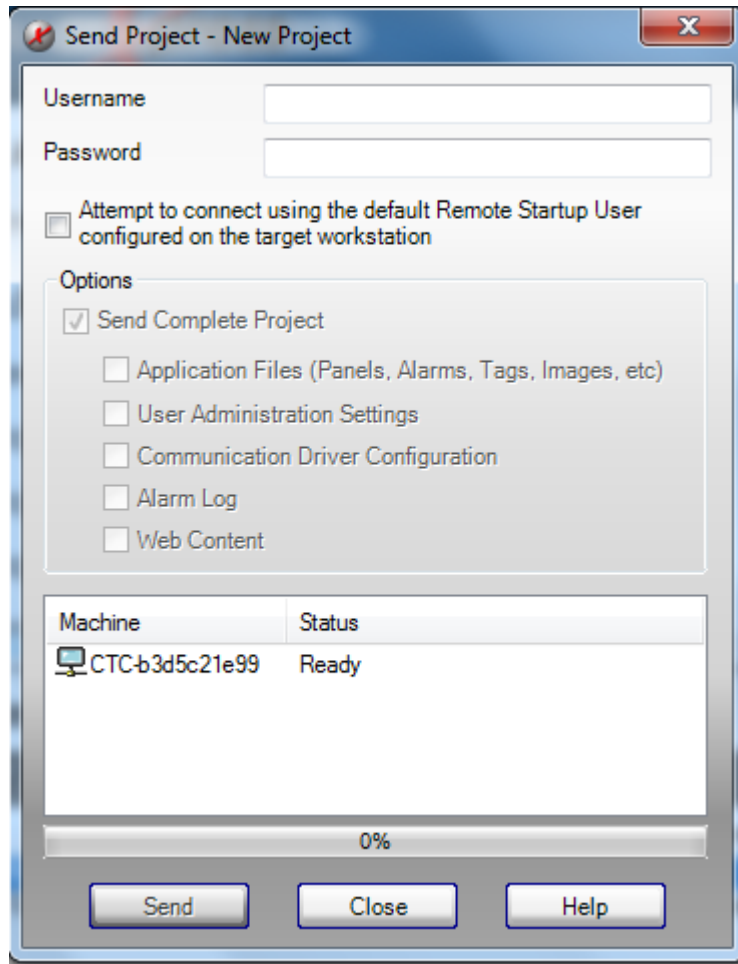

The following table provides a description of the options available from the Send Project dialog box.

Table 4-3: Sending a Project

Option	Description
Username & Password	<p>Enter the user name and password within the text box. Both text boxes default to blank the very first time. Once you enter your information, and select the Send button, it is saved for the highlighted remote machine.</p> <p>When another remote machine is chosen and its user name and password have never been set up before, these text boxes automatically fill in with the last sent user name and password.</p>

Attempt to connect...	<p>Selecting this box enables Xpress Manager to check the Remote Startup User setting on the remote machine. The Remote Startup User setting is located on the Security Options page of the Shell. The User name and Password fields are disabled if this checkbox is selected.</p> <p>If the Remote Startup User setting is configured to Login Required, the Manager issues a prompt.</p> <p>If the Remote Startup User setting is configured to a specific user, the Manager checks to see if that user has permission to edit the project. If you do not have project edit rights, the Manager alerts you.</p> <p>If you have project edit rights, then the Manager checks the number of clients that are connected to the remote machine. If there are other clients connected to the machine, then a message is displayed noting that other clients are connected.</p> <p>Note: Continuing with the Send operation forces all connected clients off the machine.</p>
Send Complete Project	<p>Select this option to send the complete project to the remote machine. The complete project includes the Panels, Tools, Tags, Alarms, User Admin Settings, and Driver configuration settings. This option is checked by default.</p>
Application Files	<p>Select this option to send the Panels, Tools, and Alarms, in the transfer. This option is only available if the Send Complete Project option is not checked.</p>
User Admin Settings	<p>Select this option to send the User Administration settings in the transfer. User administration settings are configured in the Shell. This option is only available if the Send Complete Project option is not checked.</p>
Communication Driver Configuration	<p>Select this option to send the selected driver (.dll) and the driver configuration file (database file) in the transfer. Also included in the transfer are the help and templates files. This option is only available if the Send Complete Project option is not checked.</p>
Alarm Log	<p>Select this option to send the alarm log associated with the selected project to the remote machine. This option is only available if the Send Complete Project option is not checked. By default, this option is not checked.</p>
Web Content	<p>Select this option to send the Web Content associated with the selected project to the remote machine. This option is only available if the Send Complete Project option is not checked. By default, this option is not checked.</p>
Machine	<p>The selection list defaults to the name of the remote machine that was highlighted in the remote pane before selecting the Send Project button.</p> <p>The box contains a list of all available remote machines. Click on the Machine to change to the machine you want to download to.</p>

Choosing one of these options retains the selection so that the next time you send a project, the same configuration files are sent.

Select the **Send** button to download either the entire project or selected files to the remote machine. The files that are sent to the remote machine are dependent on which option button was selected on the Send Project dialog.

Once you click the Send button, the program saves and retains the settings located under the Options section of the dialog.

For example, if you choose to download only application and driver files, the next time you download to the machine, the Xpress Manager retains this configuration.

Send Project Validation

Before sending a project, the Xpress Manager performs several validation steps to ensure that you have the correct permissions to send the project to the remote machine. These validation steps ensure that the remote machine is secure from unauthorized users attempting to download projects to the machine.

These steps are summarized below.

- System file and project compatibility are checked.
- Remote Startup User setting is checked against the current user name and password.
- User edit permissions are checked.
- Available space on the remote machine is checked.

The Xpress Manager first checks the compatibility of the system file on the remote machine and the project that is selected. If the project is newer than the version of the system file located on the remote machine, then Xpress Manager prompts you to update the system file, if one is found. You must update the system file on the remote machine before replicating the project. Refer to [Updating System Files](#) for more information.

If the system file on the remote machine is compatible with the project that is selected to download, the Xpress Manager begins a series of additional validation checks.

Xpress Manager validates the Remote Startup User configured in the Shell of the selected project. You can set the Remote Startup User option to either require a log on or a specific user.

A log in prompt is displayed if a user name and password are required. If the Remote Startup User is set to a specific user, then the current user is validated against this setting. For details on setting the Remote Startup User option, refer to *Using the Shell Environment*.

Once logged onto the remote machine, the Xpress Manager checks to see if you have permission to edit the project. If you have edit permissions, then the project transfer takes place. If edit permissions were not granted, then the project transfer does not occur.

Once all validations are confirmed, Xpress Manager notifies all other clients connected to the remote machine that they will be disconnected.

Finally, a check for available space on the target remote machine occurs. If there is insufficient storage memory on the machine then the project cannot continue to be sent and you are prompted, otherwise the transfer takes place.

When sending a different project to the remote machine than what is currently on the unit, the transfer process replaces the old project with the new one. You can see the new project in the list box of the Remote pane after the transfer is completed.

Get a Project

The Get project button is used to transfer a copy of a project from a remote machine or removable drive to the local machine. The button is grayed out if there is no remote machine or drive selected.

Initiating a Get project process transfers the complete project which includes the application, user administration, and driver configuration settings. Driver DLLs are not transferred, only the configuration settings.

During a Get project process, the remote machine is not placed in a lock down condition. Remote users can still edit or run the project.

If a project with the same name already exists on the local machine, you are prompted to overwrite the existing project. You can continue with the transfer, cancel the transfer, or rename the project. Renaming the project continues with the transfer.

If a local project is opened and you try to get a project that has the same name, the local project is closed as the transfer takes place. You must then reopen the local project.

Get Project Validation

Before getting a project from the remote machine or removable drive, Xpress Manager performs several validation steps to ensure that you have the correct permissions to get the project from the selected machine. These validation steps ensure that the machine is secure from unauthorized users attempting to retrieve projects from the remote unit. The following conditions must be correct:

- Remote Startup User setting is checked against the current user name and password.
- Available space on the local machine is checked.
- A check for the same project on the local machine is performed.

Xpress Manager checks to see if the selected remote machine requires a user name and password. If the unit does not require a user name, the Xpress Manager does not prompt you to log in and continues validation with the next step.

If the remote machine does require a user name, the Xpress Manager displays a user name and password login dialog. Once logged on, the Xpress Manager then checks for the available disk space on the local machine. If there is enough space, the Xpress Manager continues validation with the next step. If there is not enough space, the Xpress Manager prompts you with a notification of insufficient disk space.

Finally, Xpress Manager checks to see if a project of the same name already exists on the local machine. If the project does exist, you are prompted with a warning message. You can rename the project, overwrite the project, or cancel out of the transfer.

Status Bar

The status bar is located at the bottom of the Interact Xpress Manager software. This area is used to display any status messages.

During any project transfer process a progress bar at the bottom right of the Interact Xpress Manager interface displays the transfer progress.

Project Recovery

Interact Xpress Manager has features that allow recovering projects from a system crash. If the workstation where Interact Xpress Manager is installed crashes while editing a local project, upon reopening the project you are prompted with a Resume/Revert dialog.

Select **Resume** to cause Interact Xpress Manager to load the project where it was at before the crash.

Select **Revert** to cause Interact Xpress Manager to load the project at the point where it was last saved.

Any local project that was not opened will not be affected by the local workstation crashing. The Resume/Revert dialog will only appear if the project that was being edited is a local project.

Project Versioning

There are two factors that determine if a project is compatible with a specific Interact Xpress Manager machine. These factors are the machine's hardware configuration and system file version.

The hardware configuration of the Interact Xpress Manager machine is determined by the specific hardware components that make up the unit such as the display size, processor type, etc. Newer Interact Xpress Manager hardware is backward compatible with older units.

The system file is composed of the operating system, COMM server, help files, and other files that are an integral part of the HMI software. When a product enhancement such as new tools or capabilities are added to the HMI software, a new system file is generated that incorporates these updates. A new system file will always be able to read and upgrade projects created with an older version of the system file. Once a project is upgraded it may not be able to be opened with older versions of the system file.

A Interact Xpress Manager machine's hardware configuration is designed to work with specific versions of system files. These system files are able to operate with a specific set of hardware components and configuration. Interact Xpress Manager ensures that only projects that are able to operate with a specific set of system files and hardware can be sent to remote machines.

The Interact Xpress Manager software also has a specific version number. Installing a newer version of Interact Xpress Manager does not overwrite or delete any projects. With the latest version of the Interact Xpress Manager software, you are able to communicate and deploy to all Interact Xpress Manager machines that have any version of the system file. Therefore, Interact Xpress Manager is able to open and develop projects for any previous version of the system file.

The latest version of Interact Xpress Manager can be downloaded from the Web site listed below by selecting the support link: www.parkermotion.com

Interact Xpress Manager includes a feature in which you can assign a revision number to the project. This revision number is a useful tool in tracking project changes. Right click a project in the local pane and select Modify Version to keep track of changes if desired.

CHAPTER 4:
Using the Shell Environment



Shell Environment

Interact Xpress has three main environments:

- Shell
- Designer, and
- A Runtime environment.

The Shell environment (or Shell tab) is where you setup your project, manage users, and change properties and settings as needed. You can access the Shell environment through the Xpress Manager or directly on the Xpress machine. This section covers all of the options available from the Shell environment.

For information on using the Designer, refer to *Using the Design Environment*. For information on using the Runtime environment, refer to *Using the Runtime Environment*.

The Shell environment displays information about the Xpress machine and allows you to monitor and configure many of the system's hardware and software settings. You can also launch the Design and Runtime environments directly from the Shell. Because Xpress is a web-based application, you have the option of editing and running your applications, as well as managing your machine from anywhere with internet access.

The Shell Window

Each time you enter Interact Xpress from a remote machine, the Shell window is displayed as shown below. Notice that the Design button is active in this example. When you load an application for the first time, Xpress is not connected to the controller and only the Design environment is available.

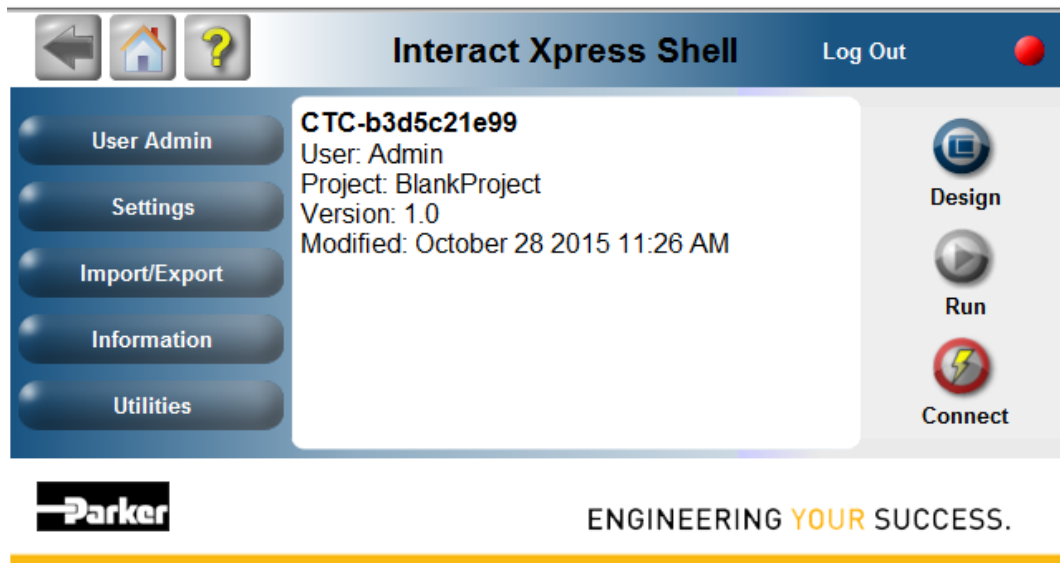

When you press the red **Connect** button, the following occurs:

1. Xpress connects with the remote machine,

2. The status light changes from red to green, and
3. The red Connect button is replaced with a green Disconnect button, indicating that Runtime is active.

You can now enter the Run environment; notice however, that you cannot enter the Design environment while connected to the controller (the Design button turns grey).

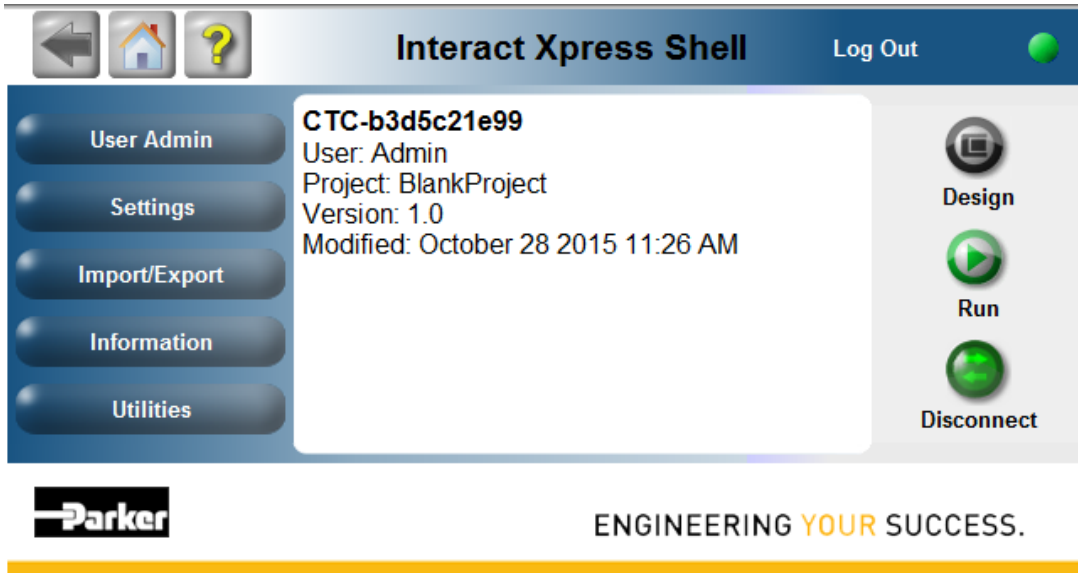

Before entering the Design or Runtime environments, you need to setup user accounts and configure project settings in the Shell environment. You can access and change these settings using the buttons on the left-hand side of the Shell page.

Using the User Admin Menu

With the User Admin menu you can manage user accounts and security options such as how many failed login attempts to allow or whether or not a login is required. From this menu you can add, edit, and delete users as well as change individual user access levels (administration, shell access, etc.).

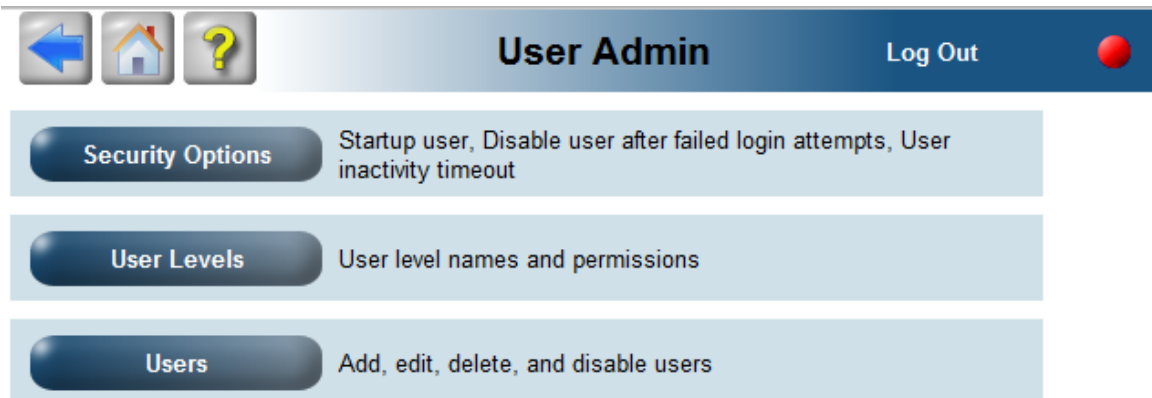

Setting Security Options

With the Security Options screen, you can specify what level of security you need in your project. For example, you can determine how many failed login attempts to allow or whether or not a login is required for each user.

To edit any of the displayed security options, click on the **Edit...** link in the upper-right hand corner of the Security Options table. The Security Options screen is displayed as shown below.

Local Startup User:

Remote Startup User:

Disable User After Failed Login Attempts

User Inactivity Timeout: Minutes

Use Timeout For Local Users:

After Local User Timeout: Show Timeout message
 Log On as Local Startup User

Use Timeout For Remote Users:

After Remote User Timeout: Show Timeout message
 Log On as Remote Startup User

OK Reset Cancel

The following table describes the options that you can change.

Property	Description
Local Startup User or Remote Startup User	Use these options to select the initial user level for the Local or the Remote User when entering Interact Xpress. You can force the user to login by selecting Login Required from the drop down box. Or you can select a specific user: administrator, engineer, supervisor, technician, operator, or guest.
Disable User After <i>X</i> Failed Login Attempts	Use this option to revoke login privileges after a specified number of failed attempts. To use this option, check the box next to Disable User. Use the drop down box to enter a maximum number of failed login attempts (from 1 to 10) before the user is locked out.



User Inactivity Timeout	Use this option to specify an amount of time that Interact Xpress can be inactive before the user is automatically logged out. The timeout period is in minutes.
Use Timeout for Local Users	Select this check box to enable the inactivity timeout for Local Users.
After Local User Timeout	Choose Show Timeout Message to show this message after the timeout period. Choose Log On as Start Up User to go to the Log On screen after the timeout period.
Use Timeout for Remote Users	Select this check box to enable the inactivity timeout for Remote Users.
After Remote User Timeout	Choose Show Timeout Message to show this message after the timeout period. Choose Log On as Start Up User to go to the Log On screen after the timeout period.

Click **OK** to accept the changes and return to the Security Options screen. Click **Reset** to reset the values to the default settings and return to the Security Options screen. Click **Cancel** to return to the Security Options screen without changing anything.

Setting User Levels

With the User Levels screen, you can view and change user access levels. The user level names displayed on the screen are the default user levels in Interact Xpress. On occasion, you may want to change the name of a user level, for example it may make more sense to change "Engineer" to "Developer" for your particular project.

You can edit all of the user levels except for the Admin user. To do so, click on the **Edit...** link in the table next to the name of the user level you want to change. The User Levels dialog box is displayed as shown below.

User Levels

Log Out

Level	Name	SA	UA	EP	
0	Admin	X	X	X	
1	Engineer	X	X	X	Edit...
2	Supervisor	X	X		Edit...
3	Technician	X			Edit...
4	Operator				Edit...
5	Guest				Edit...

Permissions:
SA = Shell Access
UA = User Administration
EP = Edit Project

The following table describes the options that you can edit.

Property	Description
User Level	There are six User Levels: 0,1, 2, 3, 4, and 5. However, you cannot edit level 0
User Level Name	Enter a new name for the user level up to 32 characters. The User Level Name can begin with a number, letter, or an underscore and is not case sensitive. The default user names are: Admin, Engineer, Supervisor, Technician, Operator and Guest.
Permissions	
Shell Access	If this box is checked, the selected user (for example, the Engineer) is allowed to enter the Shell environment. If Shell Access is not checked, User Administration and Edit Project are grayed out.
User Administration	If this box is checked, the selected user is able to access User Administration functions.
Edit Project	If this box is checked, the selected user is allowed to enter the Design environment.

Click **OK** to accept the changes and return to the User Levels screen. Click **Reset** to reset the values to the default settings and return to the User Levels screen. Click **Cancel** to return to the User Levels screen without saving.

Setting Up User Accounts

With the Users screen you can setup and disable individual user accounts. The User screen displays all of the users currently added to your project. These users can logon to a local or remote Interact Xpress machine with a correct username and password. When a user is online, there is an icon that is displayed in the title box indicating online status.

From the Users screen you can:

- Add or Edit Users
- Disable a User
- Delete a User

Interact Xpress sets up a default user administrator. You cannot delete or disable this account. The only option you can edit on the Admin account is the default password.

Add or Edit Users

From the Users screen, you can:

Add users to your project	Click on the Add User... link in the top, left corner of the Users screen.
Edit any of the displayed users	Click on the Edit... link in the table next to the user you want to change.

The Users dialog box is displayed as shown below, allowing you to add or edit a user account.

The screenshot shows a 'Users' dialog box with the following fields and options:

- Name:** Admin
- User Level:** Admin
- Locale:** German (Germany) 1031
- Password:** (empty)
- Confirm Password:** (empty)
- Change at Next Logon:**
- Startup Program:**
 - Interact Xpress Shell
 - Runtime
- Allow Local Access:**
- Allow Remote Access:**
- Runtime Privileges:**
 - None
 - Administrator

The following table describes the options available from the Users screen.

Property	Description
Name	<p>Enter a name for the new user up to 32 characters. The user name can begin with a number, letter, or an underscore. The user name field cannot be empty. If it is left blank, the last user name added is used.</p> <p>The default name is User1, with the number incrementing for each new user.</p>
User Level	<p>Select a user level from the drop down list: administrator, engineer, supervisor, technician, operator, or guest.</p>
Locale	<p>Select a project language for this user. The next time this user logs in and enters runtime, the project language will switch to match the selected language.</p> <p>The default setting is English (United States).</p>
Password	<p>Enter an initial password for the new user up to 32 characters, including spaces. You can opt to leave this field blank therefore not requiring a password. Passwords are case sensitive.</p> <p>The default setting is a blank field, thus requiring no password.</p>

Confirm Password	<p>Re-enter the password exactly as entered in the Password field. Passwords are case sensitive.</p> <p>If the Password field and the Confirm Password field do not match, while exiting the Users screen a message is displayed stating that "The entered password and password confirmation do not match."</p>
Change at Next Logon	Select this option if you want the new user to change the password at the next login.
Startup Program	<p>When the user logs on, select where you want this user to go: the Shell environment or directly into Runtime mode. The default is Runtime.</p> <p>If the User Level is set to a level that does not allow Shell Access, the Interact Xpress Shell option is grayed out and Runtime is automatically selected.</p>
Allow Local Access	<p>If this option is checked, the user can access Interact Xpress on a local machine. This is the default setting.</p> <p>If this option is unchecked and the user attempts to log on at the local machine, they are not allowed access to Xpress and the system stays on the Logon page.</p> <p>The user privileges are set according to the User Level specified.</p>
Allow Remote Access	<p>If the user needs to access a remote machine, select the runtime access allowed for this user: no access, view only access, or viewing and controlling access.</p> <p>The default option is None, no access to Runtime remotely.</p> <p>If View Only is selected, the user can log on and only view live data and navigate through panels.</p> <p>If View & Control mode is selected, the user can log on and use the Runtime mode as if they are on a local machine.</p>

Click **OK** to accept the changes and return to the Users screen. Click **Reset** to reset the values to the default settings and return to the Users screen. Click **Cancel** to return to the Users screen without saving.

Disable a User:

You can disable a user without deleting their profile from Interact Xpress. From the Users screen, find the user you want to disable and select the Disable link. If the user is currently logged on and you select Disable, the following message is displayed:

Username will be logged off immediately. Are you sure you want to disable user Username?

Click OK to disable this user and return to the Users screen. The Disable link changes to Enable and the disabled user information is grayed out in the Users screen. Click Cancel to return to the Users screen without disabling the user.

If a user is in Runtime mode and is disabled, they are logged out immediately from the Runtime session and will not be able to log back in. If the user is in the Shell and is disabled, they are logged out on the

next action (such as clicking on a link or submitting information), Interact Xpress cannot immediately boot the user off without any action. If the user is not online at all and is disabled, they will not be able to logon.

To re-enable a user, click on the Enable link while logged on an account that has Admin privileges. The user information text is no longer grayed out on the Users screen.

Delete a User:

You can delete a user permanently from Interact Xpress. From the Users screen, find the user you want to delete and select the Delete link. A confirmation dialog is displayed, "Are you sure you want to permanently delete user, User1?".

Click OK to delete this user and return to the User screen. The user information is then permanently removed from the Users screen. Click Cancel to return to the Users screen without deleting the user.

Note: If you delete a User from Interact Xpress, all user information is permanently removed from the project. You will have to Add User if you need to add that user back into the project.

You cannot delete the default Admin user account.

Using the Settings Menu

With the Settings menu you can determine how Xpress starts up, as well as enable and disable online editing capabilities and use of an on-screen keyboard. You can also set or change the name and versioning of your project, change time and date settings, calibrate your touchscreen, and setup network connections.

The Settings menu is only accessible when connected to a remote project. For detailed information on each of the options available from the Settings menu, refer to the table below.

Button	Description
General	With the General menu option you can enable Xpress to automatically connect to the controller at startup, as well as enable online editing and an on-screen keyboard.
Project	With the Project menu option you can view and set your project's name and version level.
Time and Date	With the Time and Date menu option you can change local time and date settings.
Calibrate Touchscreen	With the Calibrate Touchscreen menu option, you can launch a program that walks you through a calibration routine. You must have Shell access privileges to use the Calibrate Touchscreen option.

Network Settings	With the Network Settings menu option you can view the status of each network setting including: Machine Name, Network Connection, IP Address, Subnet Mask, Default Gateway, Primary DNS, Secondary DNS, Primary WINS, and Secondary WINS, and Proxy Server configuration options.
Email	With the Email menu option you can configure the SMTP Settings including: Outgoing Mail Server, Log On, Account Name, and Server Port Number as well as Email Settings including: From email address, To email address and Subject necessary to send Alarm notifications via email.

Setting General Options

With the General screen, you can enable Xpress to automatically connect to the machine at startup, as well as enable online editing and an on-screen keyboard.

To enable or disable the General project settings, click on the **Edit...** link in the top right-hand corner of the screen. The following table describes the different properties.

Property	Description
Connect at	Enables Xpress to automatically connect to the machine at
Online Edit	Enables you to access the Design environment while connected to a remote Xpress machine. By default, this option is disabled. For more information on using this feature, refer to <i>Using the Online Editing Feature</i> .
Use Popup Keyboard in Designer Use Popup Keyboard in Shell	Enables the on-screen keyboard to display whenever a value needs to be entered into the system. This helps to eliminate the need for a keyboard to be connected to the Xpress machine. You can choose to use the popup keyboard in the Designer only, the Shell only, or both the Design and Shell environments.
Copy Project USB on Startup	You can choose to have a project on a USB stick to be copied to the SD or CF card on power up. The project should be in a "Projects" directory on the root of the USB stick.

Click **OK** to accept the changes and return to the General screen. Click **Reset** to reset the values to the default settings and return to the General screen. Click **Cancel** to return to the General screen without saving.

Using the Online Editing Feature

If you enabled the Online Edit option, you can enter the Design environment while connected to the Xpress machine. However, any changes made to the project are updated immediately, therefore be sure you want to do this!

All of the regular Design features are available while working in online edit mode, with the following exceptions:

- Tags

The Tag editor is available, however you cannot add, delete, or modify a tag. You can however, add a local tag at the tool level.

- Alarms

The Alarm editor is available, however you cannot add, delete, or modify the alarms.

If an alarm is triggered during online editing, the alarm will beep both in the Shell and the Runtime test on the machine. If you are accessing the Designer remotely using the online editing feature, the alarm is only audible in the Runtime test.

Alarm logging works the same as it would in true Runtime, however the start and stop log times list a test run time.

Any changes you make are updated on the next alarm event.

- Popup Tools and Runtime Settings

These options are not accessible.

- Test Runtime Button

The Test Runtime button is disabled when using the Designer in online editing mode.

Changing Project Settings

With the Project screen, you can set your project's name and revision level. This is useful for long term projects with multiple releases.

To edit the project settings, click the **Edit...** link on the Project screen. The following table describes the options available from the Project screen.

Property	Description
Name	Enter a name for the new project up to 32 characters. The project name can begin with a number, letter, or an underscore. The default project name is <i>App</i> .

Version	<p>Enter a revision number for your project. The Version number is actually a combination of the predefined system version and a definable revision number. The first digit, which cannot be edited, is the system version. The second digit, which you can edit, is for project versioning.</p> <p>The revision number can be anything between 0 and 9999.</p>
---------	---

Click **OK** to accept the changes and return to the Project screen. Click **Reset** to reset the values to the default settings and return to the Project screen. Click **Cancel** to return to the Project screen without saving.

Setting the Time and Date

With the Time and Date screen, you can change the local time and date settings in your project. The time and date is updated in real time on both the local and remote Interact Xpress machines.

The following table describes the options available from the Time and Date screen.

Property	Description
Set Time Zone	Use the drop down list to select the time zone.
Set Time	Use the drop down lists to set the hour (1-12), minutes (0-59), and whether or not it is am (A) or pm (P).
Set Date	Set the Month, Day, and Year by using the drop down lists. When February is selected, if the date is set to 30 or 31, it is automatically updated to 29. The years displayed are from 2000-2100.
Daylight Saving	Select this option to activate the daylight savings settings. Your time and date will update accordingly throughout the year.

Click **OK** to accept the changes and return to the Time and Date screen. Click **Reset** to reset the values to the default settings and return to the Time and Date screen. Click **Cancel** to return to the Time and Date screen without saving.

Calibrating Your Touchscreen

With the Calibrate Touchscreen menu option, you can launch a program that walks you through a calibration routine. You must have Shell access privileges to use this option. A remote user with Shell access can get to the Settings menu, however Calibrate Touchscreen is not accessible.

Click the **Calibrate Touchscreen** button to begin calibration.

At the start of this procedure, a circle will appear in the upper left hand corner with a red dot in the middle of the circle. Use your finger or stylus to touch and hold in place until the circle goes away. This process will repeat for each of the corners of the screen. After the fourth corner, calibration is complete. To skip

the procedure, do not press the touchscreen for a few seconds to allow the software to timeout or press 'ESC' using an attached keyboard.

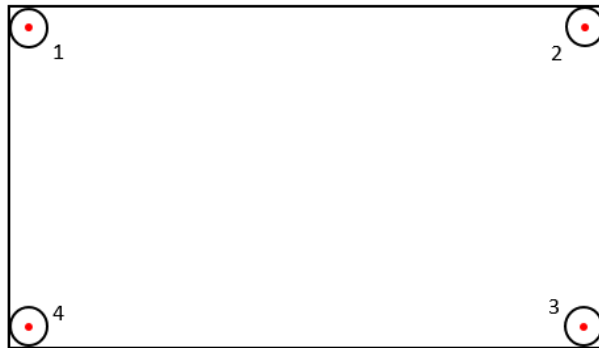

Configuring Network Settings

With the Network Settings menu option you can view the status of each network setting including: Local Area Network, Machine Name, Port Number, Network Connection, IP Address, Subnet Mask, Default Gateway, Primary DNS, Secondary DNS, Primary WINS, Secondary WINS, and Proxy Server configuration options. .

Click on the **Edit...** link to change the network settings. The following table describes the options available from the Network Settings screen.

Property	Description
Local Area Network (LAN)	The XT hardware has two LAN ports. Select the LAN port that you want to view or edit. LAN 1 by default is set to DHCP (Dynamic) with a port number of 1235. LAN 1 is recommended as the port for Office Network, but it is not limited to this option. LAN 2 by default is set to Static with an IP Address of 192.168.10.100 with Subnet Mask 255.255.0.0. LAN 2 is recommended when connecting to a controller, but it is not limited to this option.
Machine Name	Enter a unique machine name to identify this machine on a network. The machine name can be a maximum of 15 characters, using a-z, A-Z, 0-9, or underscore. The machine name must start with letters and cannot end with '-' or '_'.
Port Number	The Xpress server makes a connection with a browser on a remote machine through a specific port. You can set the port to a specific number. The port number must be 1024 or greater. The port number must be 4 numbers. The default port number is 1235.
Network Connection	

Disable	<p>Select the Disable radio button to prevent networking on the specified machine. All information should all be set to 0.</p> <p>Note: Disabling the network connection through a remote browser results in a loss of connection which can only be restored locally.</p>
Dynamic	<p>Select the Dynamic radio button to allow the local machine to automatically go out and request an IP address from the server. This IP address then is used to identify this unit on a network.</p> <p>All of the information (IP address, subnet mask, etc.) is displayed but cannot be changed in the section below Network Connection.</p>
Static	<p>Select the Static radio button to assign a fixed IP address and other network settings to this machine. This IP address and the Subnet Mask will be used to identify this unit on a network.</p> <p>The information below Network Connection (4 IP address and 4 Subnet Mask text boxes) is available and no longer grayed out. Also 4 text boxes for each Default Gateway, Primary DNS, Secondary DNS, Primary WINS, and Secondary WINS are displayed. Every IP address and subnet mask must be filled in otherwise you will receive an error. The Default Gateway, Primary DNS, Secondary DNS, Primary WINS, and Secondary WINS do not need to be filled in, they are optional.</p> <p>For further information regarding the remaining settings on this page, refer to your IT department.</p>
Subnet Mask	Enter the subnet mask required to identify the host on the network. The subnet mask provides a means of hiding the network address portion of the IP address.
Default Gateway	Enter the gateway IP address. The gateway node serves as the access point to a network.
Primary and Secondary DNS	Enter the DNS server IP address. A DNS server translates between Internet and computer names and IP addresses.
Primary and Secondary WINS	Enter the WINS server IP address. A WINS server translates Windows computer names to IP addresses.
Access the Internet user a Proxy Server	Select this box to enable the Proxy Server address and port settings. The Proxy Server forwards requests from the unit to other servers. The server retrieves data from remote web servers.
Proxy Address	Enter the IP address or the name of the proxy server. The name can be up to 15 characters long.
Proxy Port	Enter the port number of the proxy server. The number can range from 80 to 9999 with the default set to 80.

Click **OK** to accept the changes and return to the Network Settings screen. Click **Reset** to reset the values to the default settings and return to the Network Settings screen. Click **Cancel** to return to the Network Settings screen without saving.

Configuring Email

With the Email menu button, you can view and enter the settings for emailing alarm notifications.

Property	Description
SMTP Settings	
Outgoing Mail Server	Enter the target server address.
Log On	Select the Log On if you are required to log on to the Mail Server.
Account Name	Enter the required account name for the Mail Server
Password	Enter the required password for the Account Name for the Mail Server.
Server Port Number	Enter the Server Port Number for the Mail Server.
Email Settings	
From	Enter the email address to be identified as the sender of the email.
To	Enter the target email address. To send the message to multiple email addresses, separate each email address with a comma.
Subject	Enter the subject line for the outgoing email.
Test Account Settings	Use this button to send a test email with the settings selected in these fields. Be sure to select OK to enable the changed settings before sending the test email.

Using the Import/Export Menu

With the Import/Export menu you can import the following:

- Images

With the Images menu option, you can import images into your Interact Xpress project.

- Tags and Alarm Definitions

With the Tags and Alarm Definitions menu options, you can import and export tag and alarm definition files.

- Recipes and Message Tables

With the Recipes and Message Tables menu options, you can import and export recipes and message tables.

- Project and System Languages

With the Project and System menu options, you can import and export a file for use in translating your project and system text fields.

Importing and Exporting Images

Using the Images screen, you can import images into your Interact Xpress project. Once an image is imported, you can insert it onto a panel and manipulate it just like any other object from the tool box. Refer to The Image Tool, for more information on using images in your panels.

Note that you cannot drag and drop images from the desktop into Interact Xpress. You must first import the image file before you can use it in your project.

You can access the Image screen from the Shell environment or from any Images menu in the Panel editor, which is found in the Design environment.

To import images into your project, follow the steps below.

1. To access the Images screen:

From the...	Follow these steps:
Shell environment	<ol style="list-style-type: none"> Click on the Import/Export button. The Import/Export menu is displayed. Click on the Images button.
Panel editor	Click on the Background > Image > Import Image... menu command from the Panel menu.
Image tool menu	Click on the Image > Import Image... menu command from the Image menu.
Button, Indicator, or Range Indicator tool menus	<ol style="list-style-type: none"> Click on the Appearance command from the tool menu. Click on the lens state or limit range (Range indicator only) where you want to insert an image. Select the Image > Import Image... menu command from the menu.
Message editor	<ol style="list-style-type: none"> Create or highlight a message in the message table. Select the Image > Import Image... menu command from the Message editor menu.

The Images screen is displayed as shown below.

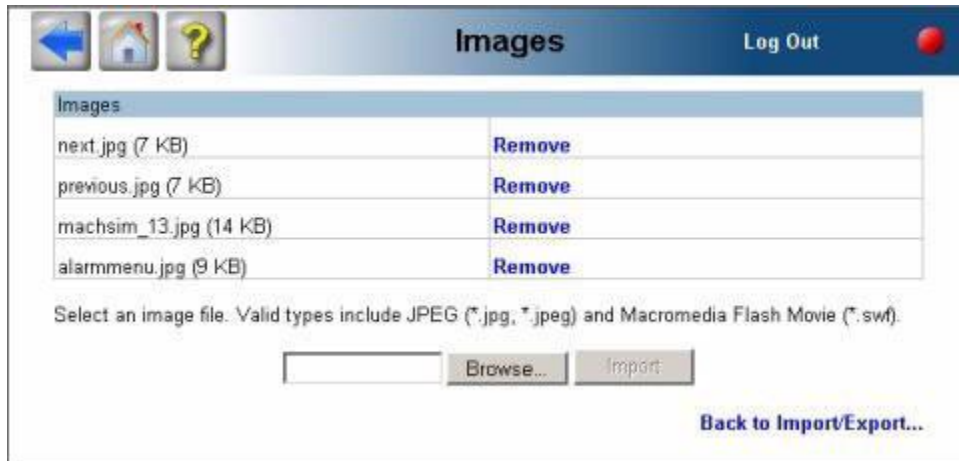

Note that when accessing the Images screen from the Shell environment, "Back to Panel..." is changed to "Back to Import/Export...". Clicking either of these links will return you to where you started

2. Select the **Browse** button to search the machine or network for the image you want to import. You can import .JPG, .JPEG and .SWF files of less than 1M in size.
3. Select **OK**. Uploading filename... is displayed on the screen. When the upload is complete, the image file is added to the Images table shown in the screen.
4. Access the imported image file from any of the Image menus in the Panel editor. Imported images are listed in alphabetical order on the menu.

Importing and Exporting Tags and Alarm Definitions

With the Tags and Alarm Definitions screen, you can import or export your tag and alarm definition files. To access the Tags or Alarm Definitions screen:

1. Click on the **Import/Export** button from the Shell environment. The Import/Export menu is displayed.
2. Click on the **Tags** or **Alarm Definitions** button. The appropriate screen is displayed. The Tag screen is shown below.
3. Select the **Browse** button to search the machine or network for the file you want to import or export.
4. Select **Import** to import the file.
5. Select **Export** to export the file. The alarm definition file is named, "Projectname_Alarm.csv" and found in the ??? directory.
6. To return to the Import/Export menu, you can either select the Back to Import/Export... link or the back arrow button on the top, left of the screen.

Importing and Exporting Recipes and Message Tables

With the Recipes and Message Tables screen, you can import or export your recipe and message table files. To import or export your tables:

1. Click on the Import/Export button from the Shell environment. The Import/Export menu is displayed.
2. Click on the Recipes or Message Tables button.
3. Select the Browse button to search the machine or network for the file you want to import or export.

- a. Select Import to import the file.

When a file is imported, the recipe file is added to the Recipe Editor. If the imported list name matches a previously created/imported list, a warning to overwrite the list is displayed. Recipe items are replaced in existing lists. If the file being imported is of the wrong format, an error message is displayed.

- b. Select Export to export the file. A Save As screen is displayed. Enter a location for the exported file.

The exported file lists all of the items in the defined format. Only one list file at a time can be selected from the drop-down list box. The default file name for each exported list matches the list name.

To delete a recipe or message table from your project, select the Remove link next to the list or table you want to delete.

To return to the Import/Export menu, you can either select the Back to Import/Export... link or the back arrow button on the top, left of the screen.

Importing and Exporting Project and System Languages

With the Project and System Languages screen, you can import or export your project and system files for translation. To import or export these files refer to Chapter 15 for complete details on Multiple Language support.

Using the Information Menu

With the Information menu you can view the system and project versions as well as system resources, such as memory usage and CPU type.

Viewing System Resources

With the System Resources screen, you can view processor, memory, and project information for your Interact Xpress machine. The processor type and speed are displayed as well as the size of your application files (such as the tag, alarm, and driver files, etc.). You can also view the available and total

amount of memory for any storage machine that Interact Xpress detected. All memory information is displayed in KB.

The following table describes the information displayed on the System Resources screen.

Resource	Description
Processor	Displays the CPU type and speed.
Memory	Displays the available onboard memory because it is integrated on the Interact Xpress hardware unit. If a storage card is used, memory information is also displayed if it is detected by the program. If there are more than one external storage machines, they will be listed as Storage Card 1, Storage Card 2, and so on.
Project	Displays each panel's memory size. It also displays the memory size of the alarm, tag, application, user admin, machine configuration, and driver files if they are available in the application. Total information represents the total amount of memory that is used by all of the applications.

Click on the Back to Information... link or the arrow in the top, left of the screen to return to the Information menu.

Viewing Versioning Information

With the Versions screen you can view the version information of the hardware platform, firmware file, the Xpress project, and any driver that resides on the machine. The following table describes the information displayed on the Versions screen. If there are several drivers they are listed in alphabetical order.

Resource	Description
Platform	Displays the version number of the hardware platform. The sequence of numbers indicates processor type and other hardware related components.
Firmware File	Displays the current version of the firmware file. The first release of the Xpress software has a firmware file version of 1.5.
Project	Displays the current version information for all files specific to the application, such as HMI, shell settings and image files. This is user selectable during project development.
Driver Versions	Displays the current driver versions used on the Interact Xpress machine.

Click on the Back to Information... link or the arrow in the top, left of the screen to return to the Information menu.

Using the Utilities Menu

With the Utilities menu you can print reports, view the logged on users and response times, as well as update the system.

Viewing the Alarm Log

With the Alarm Log screen, you can save the alarm log file to any accessible location or you can clear all logged items.

You can save the alarm log as a .TXT file, to do so:

1. Click on the Export button. The File Download dialog box is displayed.
2. Click on Save. The Save As dialog box is displayed.
3. Select the location where you want to save the alarm log.
4. Click on Save to save the file.

The alarm_log.txt uses the tab delimited format similar to other exported files, such as alarm definitions and tags. This allows you to also view the log file in a spreadsheet such as Microsoft Excel.

Alarm Log File Format

<column_headers> = first line

<log_start_time> = second line

<description>, <status>,<time>, <date>, <priority>,<alarm_value>, <group>, <user> = content lines

<log_end_time> = last line

Description = Enclosed in quotes. Text string description of the alarm.

Status= active/inactive/acknowledged/enabled/disabled (string-quotes)

Time = logged time of the alarm (string - quotes)

Date = logged date of the alarm (string - quotes)

Priority = priority of alarms as in the alarm definitions (urgent, critical, notice, warning, alert) (string - quotes)

Alarm Value = numeric value of the alarm, text value of the alarm (string for discrete items - quotes)

Group = name of the group this alarm belongs to (string - quotes)

User = user name of logged on user (string - quotes)

Clearing the Alarm Log

Use the Clear Log button to delete all of the items logged in the .TXT file. The Clear Log button is the same as using the _Alarm_ClearLog system tag. You are asked if you want to permanently delete all logged items. Selecting OK clears the log file. Selecting Cancel exits the dialog and returns to the Alarm Log screen.

Select the Back to Utilities... link or select the back arrow on the top, left of the screen to return to the Utilities menu.

Viewing Currently Logged On Users

With the Logged On Users screen, you can view a list of people who are logged on and are connected to the server unit. It displays the following information for each active user: Name, User Level, IP Address, and Access privileges.

For more information on setting up users, refer to *Using the User Admin Menu* on page 49. The following table describes the columns in the Logged on Users list.

Field	Description
Name	Represents the user that is currently logged onto the system.
User Level	Represents the user's level of security. The default levels are Admin, Engineer, Supervisor, Technician, Operator, and Guest.
IP Address	Represents the IP address of the remote unit that is online and logged on to the server. The server is labeled LOCAL rather than listing an IP Address.
Access	<p>This field displays either View Only or View & Control.</p> <p>View Only means that this user can only view and navigate through the Runtime environment. Runtime input is not allowed. However, in order for this user to navigate, button tools such as go to panel, log off, exit, and back are accessible in this mode. These tools, however, are controlled by the user level.</p> <p>View & Control means that this user can view, input value, and navigate through panels in Runtime. Tools that this user can access are based on the set up in the Designer which is tied to the User Level.</p> <p>For more information on setting access privileges, refer to <i>Setting Up User Accounts</i> on page 5-6.</p>

Viewing Response Times

With the Response Times screen, you can view the round trip response times from a Interact Xpress machine.

The information displayed on the Response Times screen is based of 20 ping samples. With 20 ping samples at 3 seconds each, this means Interact Xpress determines current, minimum, and maximum response times during that one minute then starts the next cycle of 20 samples.

The following table describes the rows in the Response Times list.

Field	Description
Average	Represents the average of the response time samples collected in one minute.
Last	Represents the last valid response time.
Fastest	Represents the fastest response time encountered during the one minute sample.

Slowest	Represents the slowest response time encountered during the one minute sample.
---------	--

Select the Back to Utilities... link or select the back arrow on the top, left of the screen to return to the Utilities menu.

Accessing Response Times in the Designer

You can access this same information in the Design environment when you put the cursor on top of the status light as shown below:

```

Response Times:
Average: 97 ms
Last: 10 ms
Fastest: 8 ms
Slowest: 1055 ms
    
```

When the status light is green, your latest ping was between 0 to 80 ms. When the light is yellow, your latest ping was between 81 and 250 ms. When the light is red, your latest ping was over 251 ms.

Understanding Round Trip Response Times

The following chart shows how a round trip response time is calculated in Interact Xpress.

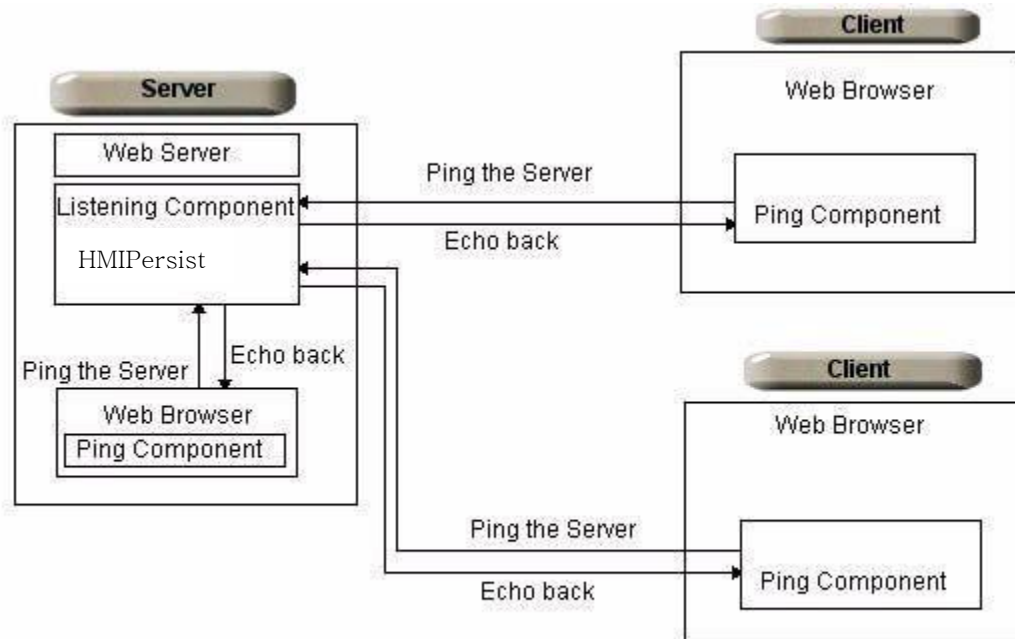

About every 3 seconds, the client sends out a ping message and waits to get the response, or echo, back from the server. The difference between the time the client pings the server and the time it receives the returned response represents the round trip Response Time value. When the client gets the returned response, it starts the next ping. This process starts as soon as the Shell environment is loaded.

Creating Reports

With the Reports screen, you can create a report and then view it. If you are accessing an Xpress machine remotely or from a desktop workstation, you can also print the report. The following table describes the type of information available. (The Creating Reports Option was removed from Xpress starting in version 3.1).

Report Type	Description
General Settings	Includes a list of the General settings that you have enabled or disabled in your project.
Project Settings	Includes project information, such as project name, version, and last modified date as well as: <ul style="list-style-type: none">■ Security options■ User Level settings■ Users
Machine Settings	Includes information about all of the machine settings in your project.
Panels	Includes information about the panels used in your project. You can choose to view all panels or select an individual panel.
Panel Graphics	If this option is checked, a picture of the panel in Runtime is displayed after each individual panel report.
Tags	Includes information about all of the tags used in your project.
Alarms	Includes information about all of the alarm used in your project.
Message Tables	Includes information about all of the message tables in your project. You can choose to view all message tables or select an individual message table.
Recipes	Includes information about all of the recipes in your project. You can choose to view all recipes or select an individual recipe.

Select Create Report and View to create the selected report(s). Once the report is created, the Shell loads this report page. The Report page is an HTML page; therefore, you must click the Print button in the dialog box in order to actually print the report you created. (Remember, you can only print if you are on a workstation or accessing the machine remotely.)

To return to the Settings menu, select the Back to Utilities... link or select the back arrow on the top, left of the screen.

CHAPTER 5: Using the Design Environment



Using the Design Environment

Interact Xpress has three main environments:

- Shell
- Designer
- Runtime

The Designer lets you create operator interface applications. This is where you build all of your panels for your application using tools, graphics, alarms, tags and other objects that perform specific tasks during Runtime. These tasks can include monitoring or controlling a machine or process. With the Designer, you can:

- **Build Panels**

Create a representation of a machine or process by using tools, graphics, alarms, and other objects. Refer to *Using the Panel Editor* for more information.

- **Add Tags**

Use tags with panel objects to control machines. Tags are objects with descriptive names configured to address data items residing locally or within a connected control machine. Output tools are used to display tag values, and input tools are used to write new values to tags.

Refer to *Using the Tag Editor* for more information.

- **Test Your Project**

Simulate or run a project created in the Designer using the Runtime environment. While in Runtime, you can navigate panels, monitor real time machine or process operation, view detected alarm conditions, or review alarm history.

Refer to *Using the Runtime Environment* for more information.

The bulk of your development is spent in the design environment. For information on using the Shell environment, refer to Chapter 5, *Using the Shell Environment*. For information on using the Runtime environment, refer to Chapter 14, *Using the Runtime Environment*.

The Design Environment

To enter the Design environment, click on the Design button from the Xpress Shell. Once in the Design environment, you should see a display similar to the one below.

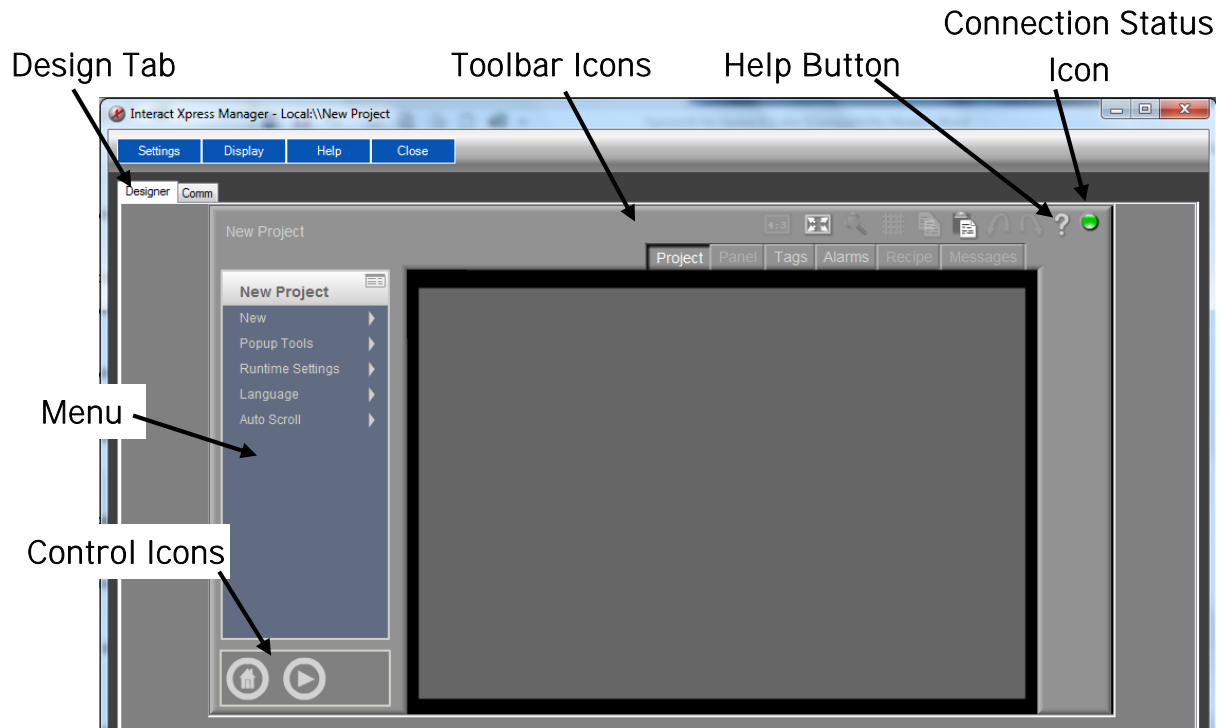











The Design environment contains the following components:

- The Toolbar Icons
- The Editor Tabs
- The Workspace
- The Menu
- The Control Icons
- Connection Status
- Properties

The Toolbar Icons

The Toolbar icons are located at the top of the Design window and are there to help you perform common tasks, such as copying and pasting objects, quickly and easily. The Toolbar icons are described below.

Icon	Hot Key	Description
	d	Shows the usable screen area for a 4:3 display (a possible future option of an XT). A red vertical line will show the right edge of a 4:3 screen. The 16x9 version of the XT hardware can use the entire viewing area.
	f	Expands the workspace area to occupy the entire display. Only the menu and workspace objects are accessible in this view.
	f	Returns the workspace to the normal view. You can also use the "F" key as a toggle to go between a full screen display and a normal screen display.
	z SPACE BAR (for panning)	Available only in the Panel Editor, zoom is used to enlarge the panel area surrounding the point where it is clicked by 4:1. While zoomed, press and hold the SPACE BAR, then click and drag the mouse to pan the zoomed panel. Click Zoom again, or press the Z hot key, to toggle back to normal 1:1 view.
	g SHIFT	Displays a grid on the panel while in the Panel Editor, and forces objects to snap to the grid while moving or sizing. Use the G key to turn the grid on and off. Press and hold the SHIFT key to temporarily enable the grid, allowing for quick and easy object aligning. Use the G key to turn the grid on and off.
	CTRL + C	Copies selected objects to the clipboard. Use paste to create a copy of the clipboard content in the current view's workspace area. Available only in the Panel and Project editors.
	CTRL + V	Copies the content of the clipboard to the workspace area. Can be used successively to create multiple copies of the item in the clipboard. Available only in the Panel and Project editors.
	CTRL + Z	Use this button to reverse or undo the last action performed on an object in the Panel editor.
	CTRL + Y	Use this button to reverse the Undo command and return the object to the state it was in before pressing Undo. This is only available in the Panel editor.
	?	Displays the Interact Xpress context-sensitive help information.

The Editor Tabs

You access the different editors through the Design environment. The tabs at the top of the Design window (below the Toolbar icons) change the workspace and menu depending on the editor you selected. The Interact Xpress editors are described in the table below.

Editor	Description
Project Editor	Use the Project editor to access all of the elements within your project, such as panels, alarms, recipes, and messages. You can add and delete these elements, setup runtime options, select the language, and configure pop-up tools such as a keypad or selection list to include on your panels.
Panel Editor	Use the Panel editor to design individual panels within your project. Using the Panel editor, you can add tools such as push buttons, gauges, meters, sliders, etc. and graphic objects such as rectangles, circles, or polygons to the panels in your project. You can also group these objects, rotate them, add text or images and even animate your objects.
Tag Editor	Use the Tag editor to configure tags for your project. A tag is a variable that is used in place of a controller-specific address or relational expression. Tags reference values from a control machine or an expression of multiple values.
Alarm Editor	Use the Alarm editor to configure alarms for your project. You can control the different levels of alarms and how they are presented to the operator, from a notice to a critical error. You can set an alarm to blink and set off an audible alarm.
Recipe Editor	Use the Recipe editor to setup a list of variables used within your project. You can set input items that use an analog, discrete, or string value.
Message Editor	Use the Message editor to setup messages displayed to the operator during runtime.

Refer to the specific editor chapters for more information.

The Workspace

The Design workspace changes depending on what editor you are currently using. In the Project editor, the Design workspace contains all of the panels, lists, and tables in your project. In the Panel editor, the panel you are currently working on is displayed in the workspace. If you are using the Alarm editor, a list of alarms and their corresponding tags are displayed. The Design workspace is dynamic, adapting to your development needs.

Below is an example of the Panel editor loaded into the Design workspace.

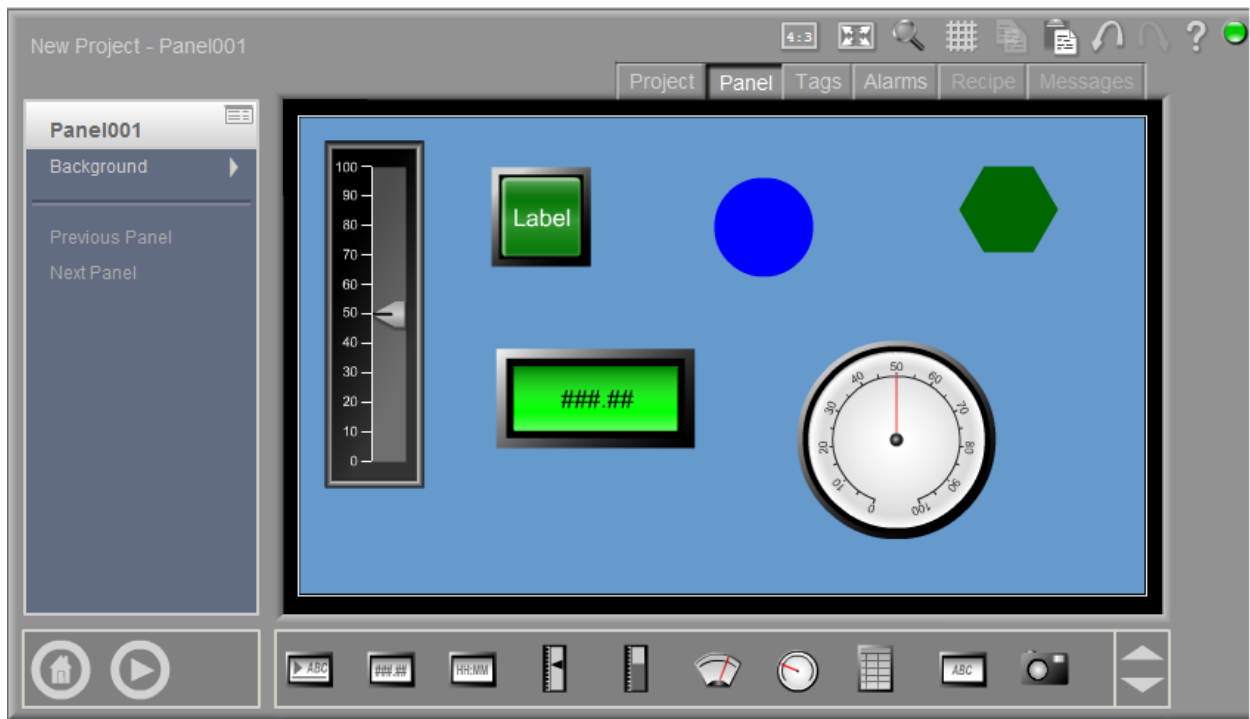

The Menu

Just as the Design workspace changes, the menu options on the left-hand side of the Design window also change depending on what editor you are using. Below is an example of the menu options available when you are using the Project editor, the Panel editor, and the Alarm editor.

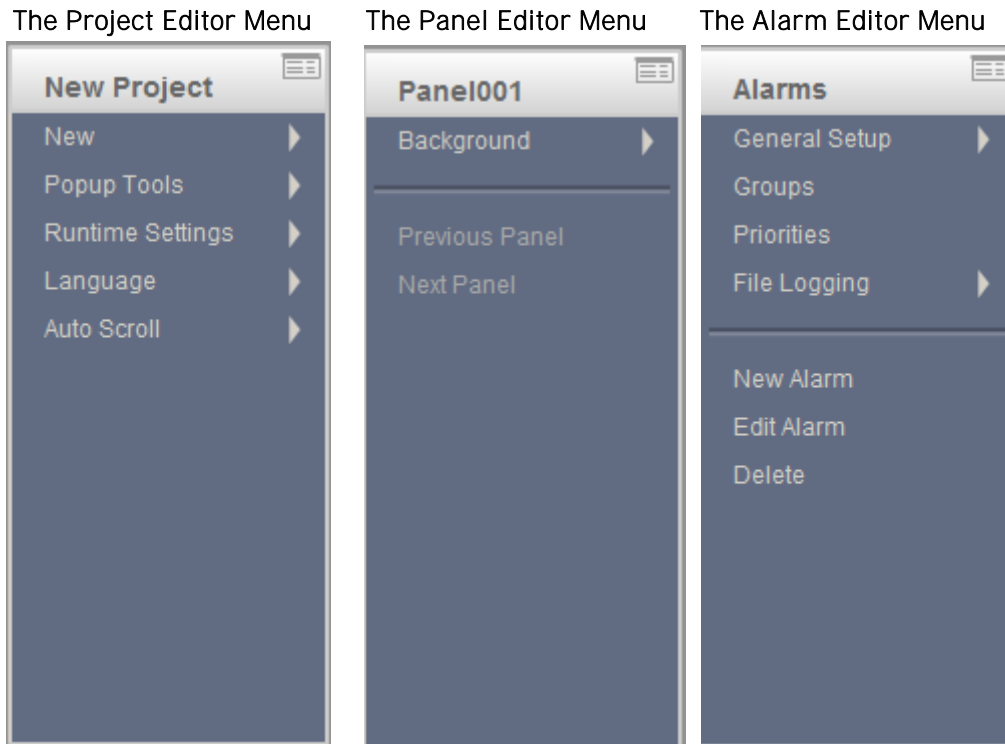

The menu items above the line are generally property settings for the editor, tool, or object you currently have selected. The menu items below the line are menu commands, such as edit and delete that affect the editor, tool, or object you are currently using.

Most submenus have a green OK and a red X icon in the top, right-hand corner of the menu as shown below. Clicking the green OK icon executes (or commits) the command. You can also click off of the submenu to execute the command. To cancel the command, click on the X icon.





For details on the common menu commands, refer to Using Common Menu Commands. Many of the menu commands can be accessed using keyboard shortcuts or hotkeys, for details see Using Keyboard Shortcuts. Lastly, see the appropriate editor for details on individual editor menus.

The Control Icons





The icons on the bottom, left-hand side of the Design window are used to switch between the different Xpress environments, and are described below.

Icon	Description
	<p>Clicking this icon closes the Design environment and displays the Shell environment. For more information, see Using the Shell.</p> <p>You can also press the Home key to go to the Shell environment.</p>

<p>Test Runtime</p> 	<p>Clicking this icon tests your project in Runtime. For more information, see Running Your Project. Note that this is not available when using the Online Editing feature.</p> <p>You can also press the F2 key to go test your project in Runtime.</p>
<p>Nudge</p> 	<p>This icon is only available when an object is highlighted in the Panel editor. Clicking this icon moves the object using smaller increments. You can also use the keyboard arrow keys to nudge an object one pixel at a time for precise positioning.</p> <p>Complete the following steps to nudge an object:</p> <ol style="list-style-type: none"> 1. Select the object that you want to nudge. 2. Press the arrow keys on the keyboard (Up, Down, Left, or Right) to nudge the object one pixel at a time. 3. Use the SHIFT key plus the nudge icon to snap the selected object to the grid.

Connection Status

The round icon on the top, right-hand corner of the Design window represents the status of the network connection. The LED icon changes color to reflect the range of response times in milliseconds, updated every 3 seconds.

Icon	Values	Description
		<p>Indicates the status of the network connection to the server.</p>
	<p>0 – 80ms</p>	<p>Green indicates an excellent network connection, where the average message response time is less (faster) than 81ms.</p>
	<p>81 – 250ms</p>	<p>Yellow indicates a good network connection, where the average message response time ranges from 81ms to 250ms.</p>
	<p>> 250ms</p>	<p>Red indicates a slow network connection, where the average message response time is longer (slower) than 250ms.</p>

When the cursor hovers over the Connection Status icon, a message box appears displaying the most recent (last) response time, as well as the average, fastest and slowest response times over the past 60 second period.

Properties

Use the Properties icon, to display a scrollable list of settings for the selected object, tool, or editor in a pop-up window, as shown below. Highlight an object you want view property information for and then click on the Properties icon. To show the properties of a particular editor, be sure nothing is selected in the editor workspace before selecting the Properties icon.

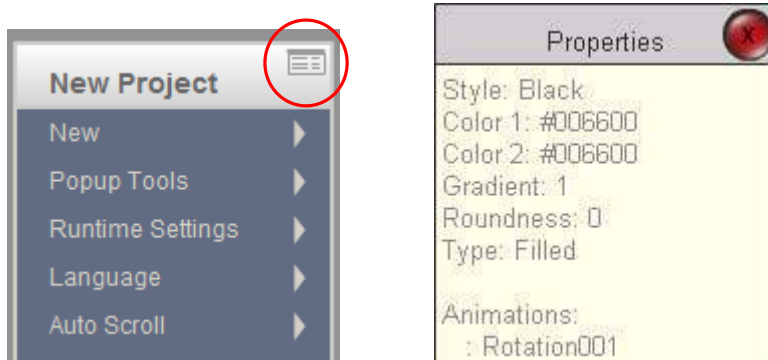

The values shown are for display only. This is very useful for displaying the properties of objects on a locked panel. A locked panel can still be viewed, but not edited. To lock a panel, refer to Using the Project Editor.

You must use the appropriate menu to change object property values. To exit out of the pop-up window, click on the red X icon.

Using the Panel Editor

Use the panel editor to develop all of your panels for your project. The workspace of the Panel editor is a blank slate for you to build as complex or as simple panels as you need for your project. The Panel editor is shown below.



Using the Panel editor, you can add tools such as push buttons, gauges, meters, sliders, etc. and graphic objects such as rectangles, circles, or polygons to the panels in your project. You can also group these objects, rotate them, add text or images and even animate your objects.

For more information on using the tools available in the Panel editor, refer to the following topics:

- The Panel Menu
- The Tool Box
- Common Menu Commands

The Panel Menu

Using the Panel menu, you can move between panels in your project, retrieve objects and modify panel background properties.

Without any objects or tools selected in the Panel editor, the menu options below are available from the Panel editor. If you have a tool or graphic object selected, such as the Ellipse in the example above, the menu displayed is for the highlighted object. For more information on using these menus, refer to the specific tool or graphic object you are working with.

Menu Item	Description
Background	<p>From this menu, you can change the background color of your panel, add a gradient to the panel, or insert and modify a background image.</p> <p>For more information, refer to the following sections:</p> <ul style="list-style-type: none"> ■ Using the Color Picker ■ Selecting a Gradient ■ Inserting a Background Image <p>In order to insert an image onto your panel, you must first import the image using the Import/Export menu. See Importing and Exporting Images for more information.</p>
Previous Panel Next Panel	These commands allow you to move between panels in your project.
Retrieve Objects	The Retrieve Objects command is only available when objects have been moved completely off the panel during a design session. Clicking on this command brings any object outside of the panel window back into view. All recovered objects are selected.

Using the Color Picker

To change the color of a Panel, an object, or another tool, you have plenty of options to choose from. When you initially select the Color 1 menu command, you can choose one of 32 different colors as shown below:



If these colors don't suit your needs, you can expand the Color Picker screen by selecting the expand button on the upper-left of the Color Picker. The expanded Color Picker screen is displayed below:

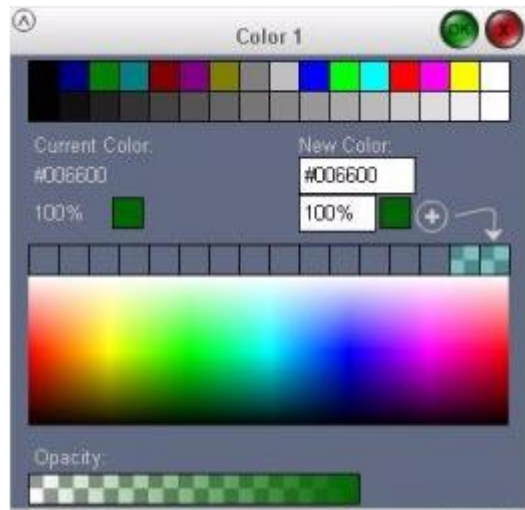

The following table describes the options available from the expanded Color Picker screen

Property	Description
Current Color	The color setting of the selected object is shown as the Current Color. The color is shown with its hex value and opacity percentage. You can select this color by clicking on it, making it easy to add to the Custom Palette. In doing so, you can save the color to apply later to another object.
New Color	The New Color field shows the color, hex value, and opacity percentage of the new color selection, which is applied to the object when the Color Picker is closed. Color and opacity may be set by typing values into the fields if desired.
Custom Palette	The Custom Palette allows you to save up to 16 custom colors. You can add colors to the palette by clicking on the + sign. Existing colors are shifted left, allowing up to 16 custom colors to be saved for later use. Note that you cannot delete colors from the custom palette. To remove a color selection, you must continually add custom colors to the palette until the one you want to delete is replaced by a new color.
Color Rainbow	The Color Rainbow shows all possible color selections. The value under the cursor is shown in the lower right corner. Clicking on the color will set it as the New Color selection.
Standard Palette	The Standard Palette provides 16 standard VGA colors and 16 shades of gray.
Opacity Bar	The Opacity Bar sets the selected color as a percentage. Far right is 100% opaque, and far left is 0% making the color transparent. Click anywhere on the bar to make a selection.

Color values are represented using #RRGGBB format. The # sign indicates hexadecimal notation, RR is the amount of red, GG is the amount of green, and BB is the amount of blue color. The values range from

00 to FF hex, where 00 is no color and FF is the maximum amount of color. Examples: #000000 is black; #FFFFFF is white; #008000 is medium green; #FFFF00 is bright yellow.

Selecting a Gradient

You can choose to use a gradient pattern on your panels or objects. To do so:

1. Select Color 1 from the Panel or object menu. Choose your initial color. See Using the Color Picker for more information.
2. Select Color 2 from the Panel or object menu. Choose your secondary color.
3. Select Gradient from the Panel or object menu. The Gradient screen is displayed as shown below:



4. Choose one of the 20 gradient patterns available. Note that grey represents Color 1 in the displayed gradient patterns and black represents Color 2. The first option is a solid Color 1, there is no gradient or Color 2 used in this pattern.
5. Select Swap Colors from the panel or object menu to swap Color 1 and Color 2, if desired.

Inserting a Background Image

Rather than having a solid color panel, you can opt to use a background image on your panels. To use an image in your project, you must first import it into your Xpress project. You can do this from the Panel editor as shown below or from the Shell environment, refer to Importing and Exporting Images for more information.

To insert an image onto a panel as a background:

1. Select **Background > Image > Import Image...** from the Panel editor menu.

The Images screen is displayed as shown below.



2. Select Browse... to find the image you want to include on your panel. You can import images in either JPG or SWF format.
3. Select Import to import that image and return to the panel.
4. Select Back to Panel... to return to the panel without saving.

To force the image fit within the panel workspace, be sure to check the Stretch Image option on the Background menu.

Deleting a Background Image

To remove a background image from the panel, select the **Background > Image > <None>** menu option from the Panel editor. The picture is removed from the panel workspace, but the image itself remains available to the project, therefore you do not have to re-import the image.

To delete an image from the project, select the **Background > Image > Import Image** menu option to access the Images screen. See Importing and Exporting Images for details on using this screen.

The Tool Box

The tool box is located on the bottom of the Design workspace and stores preconfigured tools and graphics that can be used in any panel. You can click and drag any object out of the tool box and place it on your panel. The tool box is shown below:



For information on using the rectangle, ellipse, arc, line, polygon, or text objects, refer to Working With Graphic Objects. For more information on each tool (push button, gauge, etc.), refer to Working With Tools.

Common Menu Commands

As you place objects on your panel, the menu on the left side changes accordingly. For example, if you place a button on the Panel editor, you will see the "Button" menu on the left side of the panel. These menus allow you to delete, group, align to panel, order and orient objects. They also allow you to change object properties, including color, font, size, etc.

The following table describes the common menu commands. For more information about object properties, refer to Changing Object Properties.

Menu Command	Description
Swap Colors	Switches Color 1 with Color 2 and Color 2 with Color 1. This is only available with the rectangle, ellipse, arc, and polygon tools.
Delete	Deletes the object.
Group	Groups multiple objects together. Be sure to set the individual object properties (such as desired color) before grouping objects together.
Align to Panel	Aligns the object with respect to the panel. Left, right, top and bottom commands align the object's edge with the panel's edge. Center and middle align their geometric center points.
Order	<p>Changes the "Z-order" of the object in relation to other objects on the panel. This creates a layering affect between the objects.</p> <ul style="list-style-type: none"> ■ Forward One Move the object one layer in front of where it currently sits in the stack of objects. ■ Backward One Move the object one layer behind where it currently sits in the stack of objects. ■ Send to the Front Place the object on top of all other objects. ■ Send to the Back Move the object behind all of the other objects. <p>By default, a newly created object is placed at the front of the panel, covering other objects where areas overlap.</p>

Orient	Flips the line, arc, or polygon object horizontally or vertically. Select Flip Horizontal to reverse the object along its Y-axis. Select Flip Vertical to reverse the object along its X-axis.
--------	--

Most submenus have a green OK and a red X icon in the top, right-hand corner of the menu as shown below. Clicking the green OK icon executes (or commits) the command. You can also click off of the submenu to execute the command. To cancel the command, click on the X icon.



CHAPTER 6:
Using the Tools



Using the Tools

This chapter is a tutorial that assists you in becoming familiar with developing Xpress panels with a small number of tools.

The tutorial takes about two hours to complete. It exposes you to most of the tool objects and a majority of their properties. It is recommended that you perform these steps to boost your knowledge of Xpress.

Do not skip steps as each section of the tutorial builds upon previous sections. The project you're developing will work successfully only if the steps are followed as described and in the order in which they are presented.

This tutorial assumes you are using the Interact Xpress Manager interface to create this project. You can use a browser to connect to a remote Xpress unit and perform the tutorial as well. To start the designer from your browser, enter the URL of the Interact Xpress Manager machine in your browser's address bar. Interact Xpress Manager is displayed. Other than launching Interact Xpress Manager within your browser, all other steps described below can be accomplished either through the Manager or your browser.

You will accomplish the following objectives within this tutorial:

- Create a new project and panel
- Configure buttons and indicators
- Configure meters and numeric entry tools
- Create a second panel for your project
- Configure gauges and bar graphs
- Configure message tools and recipes
- Perform various tool manipulations

Interact Xpress Manager panels are saved automatically, therefore as you progress through the tutorial, you will not have to perform any save operation as this is accomplished for you. This is another of the many great features of Interact Xpress Manager.

Creating a New Project

The first step in developing a Interact Xpress Manager application is to create a new project.

1. Launch Interact Xpress Manager from your workstation by selecting the Interact Xpress Manager **icon** from your desktop.

Interact Xpress Manager launches and displays the welcome screen in the workspace.

2. Select the **New**  icon from the local pane.

The new Panel Project dialog appears

3. Enter a name for your project such as *Tools Tutorial*.

The project is created and displays an icon within the local pane. The project launches within the workspace and Shell appears as shown below.

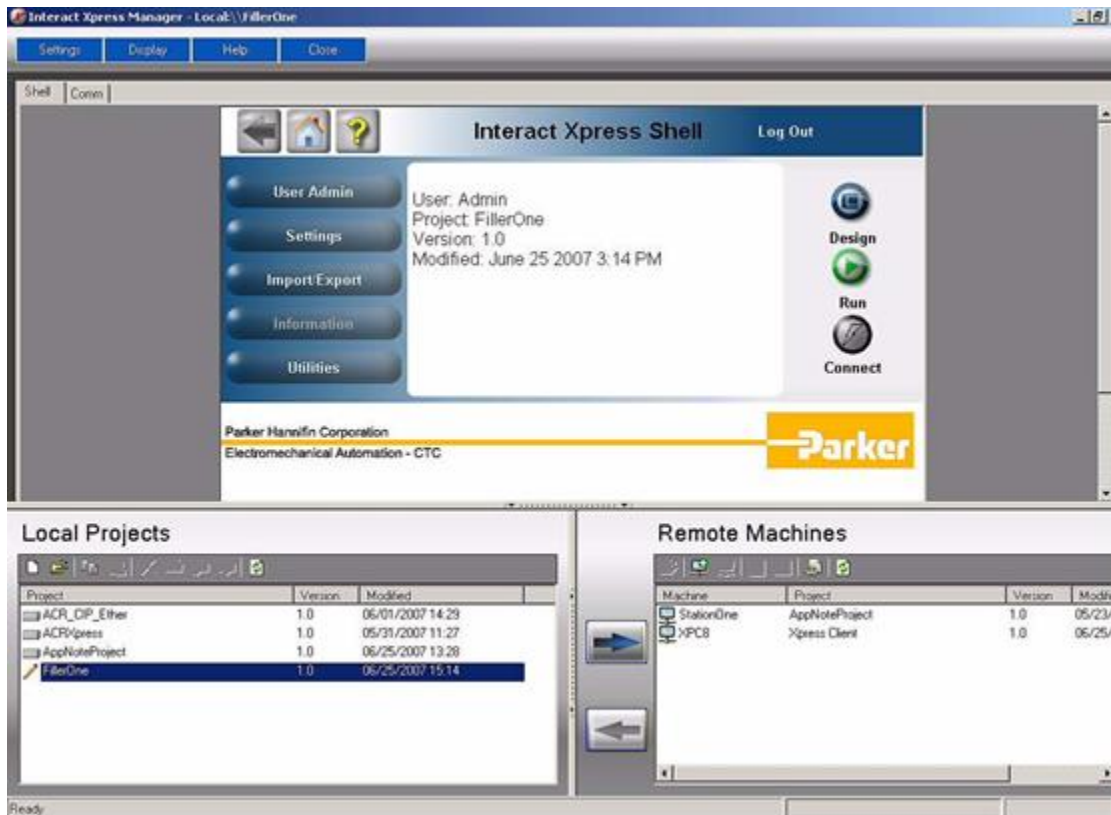

Creating a New Panel

A project consists of many items, such as driver configurations, panels, message files, etc. The next step in developing your project is to create panels.

1. With the *Tools Tutorial* project loaded in the workspace, maximize the window or browser so that you can see the entire workspace.

2. Select the **Design**  button.

The Interact Xpress Manager Designer launches within the workspace.

3. Within the Interact Xpress Manager Designer, select the **New** command from the menu.

The New fly-out appears.

4. Select **Panel** and enter a name for the panel in the Panel text box as shown below. A panel can also be created from a template. Refer to the online help system of information on templates. Name the panel *Tools1*.



5. Press **Enter** to save the panel and open the Panel Editor. You can also select the check mark in the upper right of the fly-out.

A blank panel appears. You are now ready to begin configuring your panel.

Adding Tools to a Panel

Panels can consist of tool and graphic objects. Follow these steps to add the following tools to your panel.

- Maintained button
- Indicator
- Exit button

When adding tools to your panel, you may wish to resize the tool in order to leave adequate space on your panel for further panel development.

The final panel, *Tools1*, should appear similar to the figure below. An explanation of how to add the controls is described below.

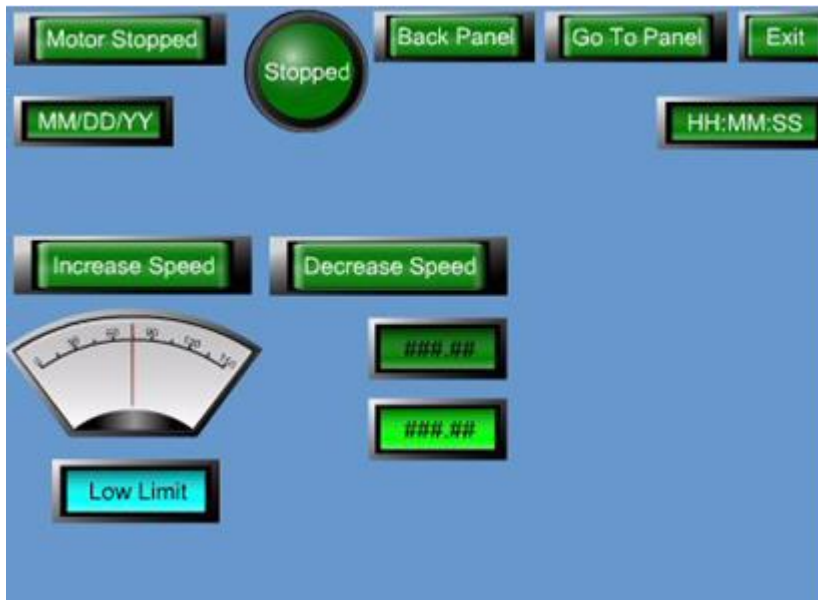

Adding the tool

1. With the *Tools1* panel open, select and drag the button from the toolbin onto the panel.

A button is created on the panel. Resize the button. The toolbin is shown below.



2. Place the button in the upper left corner of the panel by selecting the button and dragging it into place.

Moving the tool

3. When an object is selected, selection handles appear on the object. An object can be moved anytime its selection handles appear.



Sizing the tool

4. To resize an object, simply select the object, move the cursor over one of the selection handles, the cursor will change into an arrow, then move the selected handle and resize the object as desired.

Configuring the Maintained button:

With an object selected on the panel, the menu reflects all the properties and commands associated with the selected object.

1. Select each property from the menu and configure the settings as listed in the table below.

There are properties with each tool that are not listed in the table below. Leave those properties at their defaults, only change those properties listed below. You may explore the other properties if you wish.

Under the Property heading in the table, select the first property, such as *Appearance*, this will either display a fly-out menu or a secondary menu with further selections. From the fly-out or secondary menu you select the second property such as *Off Lens*.

A typical secondary menu is shown below. All secondary menus have an arrow in the upper left corner that, when selected, will take you back to the upper level menu. Therefore, selecting the left arrow in the Off Lens menu shown below returns you to the main menu.



Button Properties	Setting
Type	Maintained
Values - Switch Input	Motor1_Start
Values - Lens Output	Motor1_Start
Appearance - Off Lens -Edit Text	Motor Stopped
Appearance - Off Lens -Font Size	10
Appearance - On Lens -Edit Text	Motor Running
Appearance - On Lens -Font Size	10

2. With the button selected, resize the button so that the text fits within the bezel.

Adding and Configuring an Indicator:

1. With the *Tools1* panel open (the panel name is in the upper left corner), select and drag the indicator from the toolbar onto the panel.

An indicator is created on the panel.

2. Place the indicator in the upper left corner of the panel to the right of the button. Refer to the figure on page 7-3.

3. Select each property from the menu and configure the settings as listed in the table below.

Indicator Properties	Setting
Values - Lens Output1	Motor1_Start

Appearance - Lens State 0 - Edit Text	Stopped
Appearance - Lens State 0 - Font Size	10
Appearance - Lens State 1 - Edit Text	Running
Appearance - Lens State 0 - Font Size	10

Adding and Configuring Another Button:

1. With the *Tools1* panel open, select and drag another button from the toolbin onto the panel.
A button is created on the panel.
2. Place the button in the upper right corner of the panel to the right of the indicator as shown in the figure on page 7-3. Adjust the size of the button as necessary.
3. Select each property from the menu and configure the settings as listed in the table below.

Exit Button Properties	Setting
Type	Exit
Appearance - Off Lens -Edit Text	Exit
Appearance - Off Lens -Font Size	10
Appearance - Off Lens -Apply To All	Select this

Testing the Panel in Run Mode

Once the panel has been developed you can test it in runtime. You can quickly enter test run mode to test the functionality of your application.

1. Select the **Test Runtime**  icon in the Designer. You enter test runtime.
2. Select the **Motor Stopped** button and notice that the indicator tool reflects the Motor1_Start bit's change of state.
3. Select the **Exit** button and you return to the Designer.

Adding More Panels

You will now add the following tools to your project on the current panel -Tools1. Explore each tools properties as you add the tool to the panel. Only change the properties listed in the table for each tool to ensure the tutorial works as planned.

- Increment Button
- Decrement Button

- Meter
- Range Indicator



Adding and Configuring an Increment button:

1. With the Tools1 panel open, select and drag a button from the toolbin onto the panel.
A button is created on the panel.
2. Place the button in the middle left edge of the panel, below the button/indicator combination.
Resize the button if necessary.
3. Select each property from the menu and configure the settings as listed in the table below.

Increment Button Properties	Setting
Type	Increment
Values - Switch Input	Motor1_Speed
Values - Base Value	Motor1_Speed
Values - Increment By	10
Values - Maximum	150
Appearance - Off Lens -Edit Text	Increase Speed
Appearance - Off Lens -Font Size	10
Appearance - Off Lens -Apply To All	Select this

Now you will create a Decrement button by copying the Increment button and changing properties so that it functions as a Decrement button.

Copying the Increment button and Re-configuring it as a Decrement button:

1. With the *Tools1* panel open, select the Increment button on the panel.
2. Select the Copy  then the Paste  icon.
An exact copy of the Increment button is displayed. When making a copy of a tool, the copy will have the same shape and property settings as the original tool.
3. Move the copy to the right of the Increment button.
4. Select each property from the menu and configure the settings as listed in the table below.

Decrement Button Properties	Setting
Type	Decrement

Values - Switch Input	Motor1_Speed
Values - Base Value	Motor1_Speed
Values - Decrement By	10
Values - Minimum	0
Appearance - Off Lens -Edit Text	Decrease Speed
Appearance - Off Lens -Apply To All	Select this

Now you will create an analog read only tool. There are several types of tools that can read analog data from a controller and display it on a panel. You will now create a meter tool.

Select the down arrow in the toolbin to access additional tools. The Meter tool is located in the second drawer of the toolbin.

Adding and Configuring a Meter and a Range Indicator:

1. With the *Tools1* panel open, select and drag a meter from the toolbin onto the panel.
A meter is created on the panel.
2. Place the meter at the bottom left edge of the panel, below the increment/decrement button combination.
3. Select and drag a range indicator from the toolbin onto the panel. A range indicator is created on the panel.
4. Place the range indicator below the meter you just added.
5. Select each property from the menu and configure the settings as listed in the table below. The Meter properties are listed in the first table.

Meter Properties	Setting
Values - Tool Value Output	Motor1_Speed
Values - Min Value	0
Values - Max Value	150
Accessibility - Show Output	Motor1_Start

6. Select the range indicator on the panel and configure its properties as shown in the table below. You may have to resize the tool in order for the text to fit.

Range Indicator Properties	Setting
Values - Tool Value Output	Motor1_Speed
Values - Limit 1 Output	50
Values - Limit 2 Output	100

Appearance - < Limit 1 -Lens Color	Light Blue
Appearance - < Limit 1 -Edit Text	Low Limit
Appearance - < Limit 1 -Font Size	10
Appearance - Limit 1 to Limit 2 - Lens Color	Yellow
Appearance - Limit 1 to Limit 2 - Edit Text	Med Limit
Appearance - Limit 1 to Limit 2 - Font Size	10
Appearance - > Limit 2 -Lens Color	Red
Appearance - > Limit 2 -Edit Text	High Limit
Appearance - > Limit 2 -Font Size	10

Testing the Panel with added tools in Run Mode

1. Select the **Test Runtime**  icon in the designer.

You enter test runtime. Notice that the meter is not visible on the panel.

2. Select the **Motor Stopped** button.

The meter tool appears. This is because the Show Output property for the meter tool is assigned to the Motor1_Start tag which is controlled by the Motor Stopped maintained button.

3. Select the **increment and decrement** buttons.

The meter value increases or decreases depending on the value in the Motor1_Speed tag. Also notice that the range indicator reflects the current range of value.

4. Select the **Motor Running** button. The meter tool disappears.

5. Select the **Exit** button and you are returned to the Designer.

Adding and Configuring Numeric Entry and Numeric Display Tools:

1. With the *Tools1* panel open, select and drag a numeric entry tool from the toolbin onto the panel.

A numeric entry tool is created on the panel.

2. Place the Numeric Entry tool to the right of the Meter tool.

3. Select and drag a Numeric Display tool from the toolbin onto the panel.

A numeric display tool is created on the panel.

4. Place the numeric display tool below the numeric entry tool you just added.

5. Select each property from the menu and configure the settings as listed in the table below. The Numeric Entry tool properties are listed in the first table.

Numeric Entry Properties	Setting
Values - Numeric Entry Input	Belt_Speed
Values - Display Value Output	Belt_Speed
Values - Min Input Value	0
Values - Max Input Value	100

6. Select the numeric display tool on the panel and configure its properties as shown in the table below. You may have to resize the tool in order for the text to fit.

Numeric Display Properties	Setting
Values - Tool Value Output	Belt_Speed_Scaled
Values - Limit 1 Output	250
Values - Limit 2 Output	750

You will now edit the tag you just created, `Belt_Speed_Scaled`, and have it multiply the value in the `Belt_Speed` tag by 10. The numeric display tool will then display whatever value is entered in the numeric entry tool multiplied by 10.

7. Select the **Tags** tab at the top of the Interact Xpress Manager panel. The Tag Editor displays.

8. Locate the `Belt_Speed_Scaled` tag in the grid. Highlight the tag and select **Edit Tag**.

The Edit Tag Dialog appears.

9. In the Address field enter; `Belt_Speed * 10` as shown in the figure below.

The screenshot shows the 'Edit Tag' dialog box. The 'Name' field contains 'Belt_Speed_Scaled'. The 'Address' field contains 'Belt_Speed*10'. The 'Data Source' field contains '<auto>'. The 'Data Type' field contains 'Default'. There are also 'Initial Value' and 'Description' fields which are currently empty. The dialog has 'OK' and 'X' buttons in the top right corner and a vertical column of navigation buttons on the right side.

10. Select the check mark in the upper right corner of the Edit Tag Dialog to accept your edits and close the dialog.

You can now run the project and observe the results.

Testing the Panel with Numeric Entry and Display tools in Run Mode

1. Select the Test Runtime  icon in the Designer. You enter test runtime.
2. Select the Numeric Entry tool.
3. Enter a value between 0 and 100 and then press Enter.

The Numeric Display tool shows the value you entered multiplied by 10.

4. Select the Exit button and you are returned to the Designer.

Finishing your first Panel

There are only a few more tools to add to this first panel. You will add the following objects to the panel. Follow the steps to create these tools.

- Time display
- Date display
- Go To Panel button
- Back Panel button

You will create a Time display tool, then copy and paste the tool and reconfigure it as a Date display tool. You will then test this panel before moving on and creating a second panel for your project.

Adding and Configuring Time/Date, GoTo, and Back Panel tools:

1. Select the **Panel** tab to display the *Tools1* panel in the workspace.
2. Select and drag a Time/Date tool from the toolbin onto the panel.
A Time/Date tool is created on the panel.
3. Place the Time/Date tool in the upper right corner of the panel below the Exit button.
4. Copy and paste another Time/Date tool onto the panel.
5. Select and drag the copied tool to the opposite side of the panel.
6. Select each property from the menu and configure the settings as listed in the table below.
Configure the first Time/Date tool as a Time tool (right side of the panel) and the second (copied) Time/Date tool as a Date tool (left side of the panel). The Time tool properties are listed in the first table.

Time Properties	Setting
Type	Time

Appearance - Hour Format	24 Hour
Appearance - Time Format	HH:MM:SS

7. Select the second (copied) Time/Date tool on the panel and configure its properties as shown in the table below.

Date Properties	Setting
Type	Date

You will now create panel buttons that can be used to navigate between panels in your project. You will create Go To Panel and Back Panel buttons and configure their properties.

8. Select and drag a button from the toolbar onto the panel.

A button is created on the panel.

9. Place the button to the left of the Exit button.

10. Select and drag another button from the toolbar onto the panel.

11. Place this second button to the left of the button you just added.

12. Resize the buttons so they fit next to each other on the panel. Refer back to page 7-3 to see proper tool placement.

You will configure the first button as a Go To Panel button and the second button a Back button.

13. Select each property from the menu and configure the settings as listed in the table below.

GoTo Panel Button Properties	Setting
Type	Goto Panel
Values - Panel - New Panel	Tools2
Appearance - Off Lens -Edit Text	Go To Panel
Appearance - Off Lens -Font Size	10
Appearance - Off Lens -Apply To	Select it

Creating a Go To Panel button allows you to enter a name for the panel in the New Panel text box. This creates a new panel for your project. If you select the **Project** tab, there will now be two panels for the project, *Tools1* and the newly created *Tools2* panel.

14. Select the second button on the panel and configure its properties as shown in the table below.

Back Button Properties	Setting
Type	Back

Appearance - Off Lens -Edit Text	Back Panel
Appearance - Off Lens -Font Size	10
Appearance - Off Lens -Apply To All	Select it

15. Move the tools around on the panel so that the panel presents an aesthetically pleasing display. You will now run the project and observe the results.

The final panel should look something like the figure on page 7-3.

Testing the Panel with Time/Date tools in Run Mode

1. Select the **Test Runtime**  icon in the designer.

You enter test runtime. The Time and Date displays show the current time and date as read from your workstation.

2. Select the **Back Panel** button.

Nothing happens because the Back panel button will take you to the last panel visited, functioning like the Back button on your Internet browser. Since there were no panels previously visited, selecting the Back button will do nothing.

3. Select the **Go To Panel** button.

The panel, *Tools2*, displays as that was the panel you configured this button to access. This panel is blank as we have not placed any tools on it for now. You cannot return to the previous panel as there are no navigational buttons on this panel.

4. Since we are running in Test Runtime mode, simply select the **Exit Runtime**  icon on the panel to return to the Designer.

Adding Tools to the Second Panel in your Project

This section of the tutorial continues with configuration of additional tool objects. Up to this point you have been working with the first panel in the project, *Tools1*. This second panel allows you to continue exploring the many tools available with Interact Xpress Manager.

The following tools will be added to this panel:

- All previous project navigation buttons (Exit, Go To Panel, Back Panel)
- Slider
- Gauge
- Bar Graph

The final panel, *Tools2*, should appear similar to the figure below.





Copying Tools between Panels

The *Tools2* panel needs to consist of all the navigational elements that are contained on the first panel you created. You can copy and paste objects among panels to save time in tool configuration. You will copy the Exit, Go To Panel, and Back Panel buttons from the *Tools1* panel and make a small change to the Go To Panel button.

1. With the *Tools1* panel open select the Exit, Go To Panel, and Back Panel buttons.

Holding down the Ctrl key allows multiple object selections. As each object is selected, handles appear on the tool.

2. Release the Ctrl key.
3. Select the **Copy**  button on the Designer.
4. Select the background of the panel.
5. Select the **Next Panel** command from the menu.
6. Select the **Paste**  button on the Designer.

Position the tools in the lower right corner of the panel. The *Tools2* panel now has three navigational buttons located on the display.

7. Select only the Go To Panel button to change the tools configuration. Select each property from the menu and configure the settings as listed in the table below.

GoTo Panel Button	Setting
Type	Goto Panel

Values - Panel - New Panel	Tools3
----------------------------	--------

Just as was accomplished before, this creates a new panel for your project. If you select the **Project** tab, there will now be three panels for the project, *Tools1*, *Tools2*, and the newly created *Tools3* panel.

Testing the Tools2 Panel navigation buttons in Run Mode

1. Before going into Test Runtime mode, select the **Previous Panel** command from the *Tools2* panel.

The *Tools1* panel displays in the workspace.

2. With the *Tools1* panel in the workspace, select the **Test Runtime**  icon in the Designer.

You enter test runtime.

3. Select the **Go To Panel** button.

The *Tools2* panel displays as that was the panel you configured this button to access.

4. Select the **Back Panel** button.

The *Tools1* panel displays because it was the previously visited panel.

5. Select the **Go To Panel** button, again, from the *Tools1* panel. The panel, *Tool2*, displays.

6. Select the **Go To Panel** button from the *Tools2* panel.

The panel, *Tools3*, displays as that was the panel you configured this button to access. This panel is blank as you have not placed any tools on it for now.

Since you are running in Test Runtime mode, simply select the **Exit Runtime**  icon on the panel to return to the Designer.

Adding and Configuring the Slider, Gauge, and Bar Graph tools on the Tools2 Panel

1. Open the *Tools2* panel in the Designer by either selecting it from the Project workspace or selecting the **Next Panel** command from the Tools1 menu.

2. With the *Tools2* panel open, select and drag a Slider tool from the toolbin onto the panel.

A Slider tool is created on the panel.

3. Place the Slider tool in the upper left corner of the panel.

4. Select and drag a Gauge tool from the toolbin onto the panel. A Gauge tool is created on the panel.

5. Place the Gauge tool to the right of the Slider tool.

6. Select and drag a Bar Graph tool from the toolbin onto the panel. A Bar Graph tool is created on the panel.
7. Place the Bar Graph tool to the right of the Gauge tool.
8. **Resize** the tools to achieve an aesthetically pleasing panel. Refer to page 7-14 for your reference.
9. Select each property from the menu and configure the settings as listed in the table below. First configure the Slider, followed by the Gauge and Bar Graph tools. Refer to the appropriate table for configuration settings.

Slider Properties	Setting
Values - Slide Input	Slide_Data
Values - Slide Output	Slide_Data
Values - Min Value	0
Values - Max Value	50

Gauge Properties	Setting
Values - Tool Value Output	Slide_Data
Values - Min Value	0
Values - Max Value	50

Bar Graph Properties	Setting
Values - Tool Value Output	Slide_Data
Values - Limit 1 Output	20
Values - Limit 2 Output	40
Values - Min Value	0
Values - Max Value	50

Testing the Tools2 Analog Tools in Run Mode

1. With the *Tools2* panel in the workspace, select the  icon in the designer.
You enter test runtime.
2. Select the **Slider** tool and move the knob up and down.
The Gauge and Bar Graph tool values reflect the data input through the Slider.
3. Select the **Exit** button.
You are returned to the Designer.

Creating a New Panel with Message Tools

Interact Xpress Manager is able to display ASCII messages using its Message Display tool. The Message Display tool can be configured in one of three different ways. It can display pre-configured messages based on a trigger, system information messages, or it can allow you to enter ASCII text messages to be written to a control machine or another tool.

The final panel, *Tools3*, should appear similar to the figure below.



1. With the *Tools2* panel open, select the Exit, Go To Panel, and Back buttons from the panel.
2. Select the **Copy** button from the menu bar.
3. Click the background of the *Tools2* panel.

The Panel menu displays.

4. Select the **Next Panel** command to open the *Tools3* panel.
 5. Select the **Paste** button from the menu bar and position the panel navigation buttons in the lower right corner of the *Tools3* panel.
 6. With the *Tools3* panel open, select and drag a Message tool from the toolbin onto the panel.
- A Message tool is created on the panel.
7. Place the Message tool in the upper left corner of the panel.
 8. Select and drag another Message tool from the toolbin onto the panel and place it in the upper right corner.

A second Message tool is created on the panel.

9. Select each property from the menu and configure the settings as listed in the tables below. Configure the first Message tool (left corner) then configure the second Message tool you placed on the panel. Refer to the appropriate table for configuration settings.

Left Message Display Properties	Setting
Type	Message Entry
Actions - Max Message Length	200
Actions - Clear Upon Select	Checked
Values - Message Input	Message_Text
Values - Message Output	Message_Text
Values - Message Source	Remote

Right Message Display	Setting
Type	Display Only
Values - Message Output Values - Message Source	Message_Text Remote

Testing the Message Tools in Run Mode

1. With the *Tools3* panel in the workspace, select the **Test Runtime**  icon in the designer.

You enter test runtime.

2. Select the upper left Message tool.
3. Type in a text message and press **Enter**.

The message now appears in this Message tool along with the Message tool to the right.

4. Select the **Exit** button.

You are returned to the Designer.

Adding a Message File and Message Tool to the Tools3 Panel

Another function of the Message Display tool is to read a message file of pre-defined ASCII text messages and display those messages on the runtime panel. Messages can be created in Interact Xpress Manager, as the following steps will demonstrate. You can also create messages in Microsoft Excel and import that message file into Interact Xpress Manager.

In this section of the tutorial you will create a list of messages and display them in the Message Display tool based on a trigger. You must first create the message file then correctly configure a Message Display tool in order to display messages.

Creating a Message File

1. Select the **Project** tab from the Designer workspace. The Project view is opened.
2. Select **New** from the menu.
3. Select **Message Table** from the fly-out.
4. Enter *MsgFile1* for the Message Table name. The Message Editor opens as shown below.

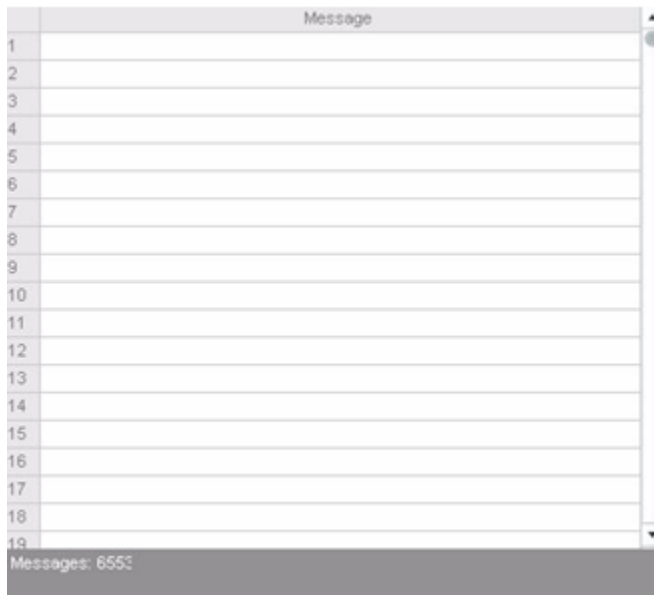

Now add a list of five text messages for this file. Each of these messages correspond to a message number. In runtime each message will be displayed when its message number is loaded into the designated address

5. Double-click on the row next to number 1 and enter the text "*Message Number 1*".
6. Click the check mark in the upper right corner.
7. Double-click on the row next to number 2 and enter the text "*Message Number 2*".
8. Click the check mark in the upper right corner.
9. Double-click on the row next to number 3 and enter the text "*Message Number 3*".
10. Click the check mark in the upper right corner.
11. Double-click on the row next to number 4 and enter the text "*Message Number 4*".
12. Click the check mark in the upper right corner.
13. Double-click on the row next to number 5 and enter the text "*Message Number 5*".
14. Click the check mark in the upper right corner.

As you enter each message the menu displays the properties that apply to that particular message. This makes it possible for each message to have a unique font color, font size, and font style. You can also add images to a message text string.

15. Select the **Project** tab from the menu bar.

The Project view is displayed with Message File - "*MsgFile1*" displayed as part of the project. Now you will add a Message Display tool to display the messages from this file.

Creating a Message Display Tool to display Message File text

1. Select the *Tools3* panel from the Project workspace then select **Edit** from the menu.

The *Tools3* panel opens.

2. Select and drag a Message tool from the toolbin onto the panel.

A Message tool is created on the panel.

3. Place the Message tool to the left of the panel, below the first Message tool.

4. Select each property from the menu and configure the settings as listed in the table below.

Message Properties	Setting
Type	Display Only
Values - Message Output	Message_Number
Values - Message Source	MsgFile1

5. With the Message tool selected, click the **Next Message** command from the menu.

The Message tool displays the first message from the message file. You may have to resize the Message tool in order to see the complete message text.

6. Continuing to click the **Next Message** command will cycle through all the messages in the message file.

Now you will add an Increment and Decrement button to allow cycling through the messages in the message file while in runtime.

Adding an Increment and Decrement button to the Tools3 Panel

1. Select and drag a button tool from the toolbin onto the panel. A button tool is created on the panel.
2. Drag the button below the Message tool and to the left.
3. Select and drag another button from the toolbin onto the panel. A second button is created on the panel.
4. Drag this button below the Message tool and to the right of the first button.

5. Select each property from the menu and configure the settings as listed in the table below for each button. Make the left button an Increment button and the right button a Decrement button.

Increment Button Properties	Setting
Type	Increment
Values - Switch Input	Message_Number
Values - Base Value	Message_Number
Values - Increment By	1
Values - Maximum	5
Appearance - Off Lens -Edit Text	Inc Msg
Appearance - Off Lens -Font Size	10
Appearance - Off Lens -Apply To All	Select it

Decrement Button Properties	Setting
Type	Decrement
Values - Switch Input	Message_Number
Values - Base Value	Message_Number
Values - Decrement By	1
Values - Minimum	0
Appearance - Off Lens -Edit Text	Dec Msg
Appearance - Off Lens -Font Size	10
Appearance - Off Lens -Apply To All	Select it

Each of the Message Display tools on this panel are configured for different functions. You will now add some text to the panel that names each displays purpose.

6. Select and drag a text object from the toolbin onto the panel. A text object is created on the panel.
7. Select and drag two more text objects from the toolbin onto the panel.
8. Drag each text object to a position that is above each Message Display tool and centered over the tool.

The final panel should appear as shown on page 7-3.

9. Select each text object, select the **Edit Text** command and enter the text as shown in the figure on page 7-18.

Testing the Message Tools with a Message File in Run Mode

1. With the *Tools3* panel in the workspace, select the **Test Runtime**  icon in the designer.

You enter test runtime.

- 2 Select the **Increment** button.

Each time you click the Increment button the Message Display tool displays the message text associated with the number. Message text is derived from the message file you created earlier. Use the Decrement button to move back through the message file.

3. Select the **Exit** button.

You are returned to the Designer.

Creating a New Panel with Selection Entry and Recipe Tools

The Selection Entry and Recipe tools provide extended control functionality for your application. The Selection Entry tool allows you to create a list of pre-configured numeric values for the operator to use in runtime. The Selection Entry tool also allows you to assign a meaningful name or description for each value allowing the operator to associate a name for a particular setting rather than just a numeric value.

At this point in the tutorial it is assumed you have become familiar with the process of creating new panels and placing navigational controls on the new panel. Refer to previous sections for these details.

After adding the Selection Entry tool, you will add a Numeric Display tool that is used to verify items sent by the Selection Entry tool.

The final panel, *Tools4*, should appear similar to the figure below.



Adding a Selection Entry and Numeric Display Tool

1. Create a fourth panel for your project and name it *Tools4*.
2. Copy the Exit, Go To Panel, and Back buttons from a previous panel and paste them onto the *Tools4* panel.

You are now ready to add the Selection Entry and Recipe tools.

3. With the *Tools4* panel open, select and drag the Selection Entry tool onto the panel, placing the tool in the upper left corner of the panel.
4. Select and drag the Numeric Display tool from the toolbin and position the tool to the right of the Selection Entry tool.
5. Select each property from the menu and configure the settings as listed in the tables below. Refer to the appropriate table for configuration settings.

Selection Entry Properties	Setting
Values - Selection Entry Input	<i>Select_Entry</i>
Values - Display Value Output	<i>Select_Entry</i>
Selections - Click on the + <icon> icon to add an item to the selection list.	Name: <i>Meters/Second</i> - Select the Name box to enter this text. Value: <i>1</i> - Select the Value box to enter this value. Name: <i>Feet/Second</i> Value: <i>2</i>

The selection list should look like the figure below when completed.

6. Click the check mark in the upper right corner of the Selection list to accept the values and close the list.
7. Select the Numeric Display tool and configure its settings as shown below.

Numeric Display Properties	Setting
Values - Tool Value Output	<i>Select_Entry</i>
Values - Limit 1 Output	0
Values - Limit 2 Output	2

Testing the Message Tools in Run Mode

1. With the *Tools4* panel in the workspace, select the **Test Runtime**  icon in the designer. You enter test runtime.
2. Select the **Selection Entry** tool.
The Selection List popup appears
3. Select **Meters/Second** from the list then click **Accept**.

The Selection Entry tool displays the selection entered and the Numeric Display tool shows actual values that would be entered in the controller.

4. Select the **Selection Entry** tool again then select **Feet/Second** from the popup list. Click **Accept** to send this value.
5. Select the **Exit** button.

You are returned to the Designer.

Adding a Recipe to the Project

The Recipe tool allows you to configure multiple lists of data items that can be written to the controller. A list is a collection of controller variables that contain preset values that control the components and quantities used in a process. Each list includes a name for the list and an array of items consisting of a short text description and a data value.

You can configure buttons to select a list, edit data values, save new data values, and send the list to the controller.

The lists that are used by the Recipe tool are configured through the Recipe Editor interface. You will first create a recipe then configure a Recipe Viewer to display the list to the user. You will also configure buttons to perform the list operations discussed above.

1. Select the **Project** tab from the Interact Xpress Manager toolbar.
2. Select **New**, then Recipe.
3. Enter the name as *My_List*.

A new Recipe is created for the project. The recipe grid is displayed. You will now enter five items within the grid.

4. Select **New Item** from the menu.

The Edit Recipe Item dialog displays as shown below with the first recipe item populated.

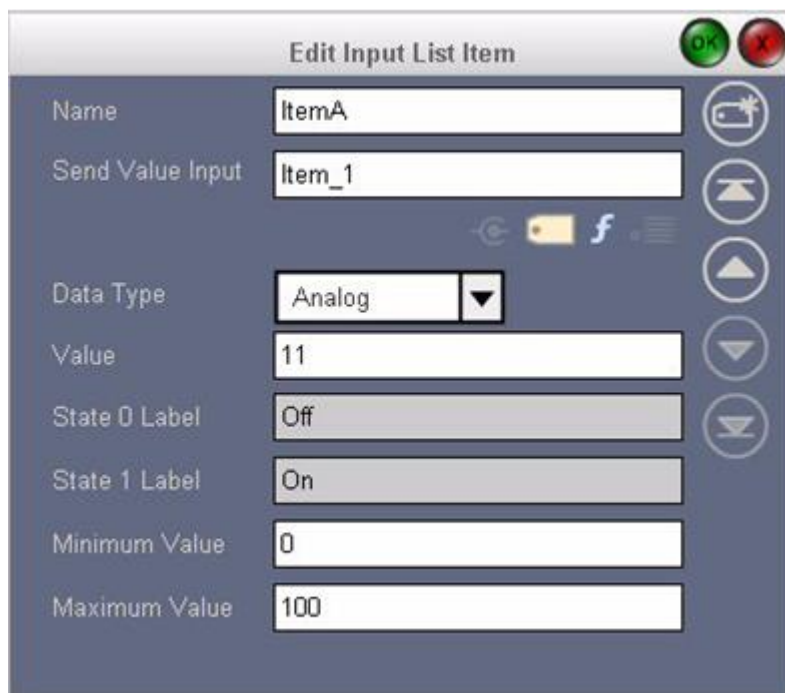

5. Configure the five recipe items as shown in the table below. Select the **Create a New Recipe** item button  after entering each items configuration information.

Recipe Item Dialog Configuration	Setting
Recipe Item 1	Name: <i>ItemA</i> Send Value Input: <i>Item_1</i> Data Value: <i>Analog</i> Value: <i>11</i> Minimum Value: <i>0</i> Maximum Value: <i>100</i>
Recipe Item 2	Name: <i>ItemB</i> Send Value Input: <i>Item_2</i> Data Value: <i>Analog</i> Value: <i>22</i> Minimum Value: <i>0</i> Maximum Value: <i>100</i>
Recipe Item 3	Name: <i>ItemC</i> Send Value Input: <i>Item_3</i> Data Value: <i>Analog</i> Value: <i>33</i> Minimum Value: <i>0</i> Maximum Value: <i>100</i>

Recipe Item 4	Name: <i>ItemD</i> Send Value Input: <i>Item_4</i> Data Value: <i>Analog</i> Value: <i>44</i> Minimum Value: <i>0</i> Maximum Value: <i>100</i>
Recipe Item 5	Name: <i>ItemE</i> Send Value Input: <i>Item_5</i> Data Value: <i>Analog</i> Value: <i>55</i> Minimum Value: <i>0</i> Maximum Value: <i>100</i>

Now that a list is configured, you will create an Recipe Viewer tool along with button tools to load the list into the panel and then send the list.

Adding a Recipe Viewer to the Panel

1. Select the **Panel** tab from the Interact Xpress Manager toolbar. The *Tools4* panel displays.
2. With the *Tools4* panel open, select and drag the Recipe Viewer tool onto the panel, placing the tool below the Selection Entry tool.

You will not need to configure Recipe Viewer properties as you will use the current tool defaults.

You will now add and configure buttons that are used with the Recipe Viewer to load and send a list during runtime. In addition, you will add Numeric Display tools to the panel in order to display the results of transferring a list to a control machine.

3. Select and drag two buttons onto the panel. Place the buttons below the Recipe Viewer.
4. Resize all the panel tools so that room is available for all tool objects.
5. Select and drag five Numeric Display tools onto the panel. Place them along the right side of the Recipe Viewer.

You can also create one Numeric Display tool, then copy the tool and paste it four additional times.

6. Configure the two buttons and five Numeric Display tools as shown in the tables below. Refer to the appropriate table for configuration settings. You must select each Numeric Display tool, individually, to display the tools properties in the menu.

The final *Tools4* panel should look like the figure shown on page 7-24.

Load List Button Properties	Setting
Type	Momentary
Values - Switch Input Values - Lens Output	<i>ListViewer.LoadList</i> Note: <i>LoadList</i> is a Recipe Viewer system tag. You can select this tag from the drop-down list that appears. <i>ListViewer.LoadList</i>
Appearance - Off Lens -Edit Text Appearance - Off Lens -Font Size Appearance - Off Lens -Apply To All	Load List 10 Click it

Send List Button Properties	Setting
Type	Momentary
Values - Switch Input Values - Lens Output	<i>ListViewer.SendList</i> Note: <i>SendList</i> is an Recipe Viewer system tag. You can select this tag from the drop-down list that appears. <i>ListViewer.SendList</i>

Send List Button Properties	Setting
Appearance - Off Lens -Edit Text Appearance - Off Lens -Font Size Appearance - Off Lens -Apply To All	Send List 10 Click it

Numeric Display Tool Properties	Setting
First Numeric Tool	Values - Tool Value Output: <i>Item_1</i>
Second Numeric Tool	Values - Tool Value Output: <i>Item_2</i>
Third Numeric Tool	Values - Tool Value Output: <i>Item_3</i>
Fourth Numeric Tool	Values - Tool Value Output: <i>Item_4</i>
Fifth Numeric Tool	Values - Tool Value Output: <i>Item_5</i>

Testing the Recipe Viewer Tools in Run Mode

1. With the *Tools4* panel in the workspace, select the **Test Runtime**  icon in the designer. You enter test runtime.
2. Select the **Load List** button.
A Selection List popup appears

3. Select **My_List** from the list then click **Accept**.

The Recipe Viewer displays the recipe items along with their values.

4. Select the **Send List** button.

The list is sent and the Numeric Display tools display the value for each recipe item. This simulates sending a list to the control machine.

5. Select the **Exit** button.

Manipulating Objects

This section of the tutorial allows you to experiment with several object manipulation features such as those in the list below:

- Grouping/Ungrouping
- Ordering
- Aligning
- Match Size
- Distributing
- Orienting

In order to experiment with these features, you will first create a new panel then place objects on the panel.

Creating a New Panel

At this point in the tutorial it is assumed you have become familiar with the process of creating new panels and placing navigational controls on the new panel. Refer to previous sections for these details.

1. Create a fifth panel for your project and name it *Tools5*.
2. Copy the Exit, Go To Panel, and Back buttons from a previous panel and paste them onto the *Tools5* panel.

You are now ready to add tools.

Grouping/Ungrouping Objects

The Group feature allows you to take several objects and apply the Group command to those objects. Once grouped together, the multiple objects are treated as one object and the selection highlight surrounding the group reflects that these are no longer manipulated as separate objects, but as a single group.

1. With the *Tools5* panel open in the workspace, select and drag three buttons onto the panel.
2. Select each button and hold down the Ctrl key with each selection.

As you select each button, sizing handles appear on all three buttons indicating they are currently selected.

3. Select the **Group** command from the menu.

The buttons are formed into a single group. The menu displays all commands associated with this type of grouped object. You can move and resize the group as you would any other object.

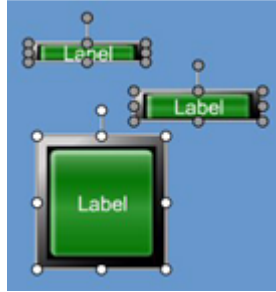

4. With the group highlighted, select the **Ungroup** command. The group is now split into individual objects.

Order Objects

Ordering objects refers to changing the layering of objects on the panel on top of or underneath other panel objects. This is also referred to as the Z order of the objects on a panel.

1. With the *Tools5* panel open in the workspace, select the buttons on the panel and stack each one over the other so that a portion of each button is visible from the edge.

This allows you to notice the order of each object on the panel. The first object placed on the panel appears underneath all other objects.



2. Select the topmost button on the panel.
3. Select **Order -> Backward One** from the menu.

The selected object moves below the next object in the stack of layered objects.

4. With the object still selected, select **Order -> Forward One** from the menu.

The selected object moves to the top of the stack. Select the other objects and experiment with the Order command options.

Align Objects

Aligning objects is extremely useful for quick and easy lining up of multiple objects on the panel relative to one another. You can align objects; left, center, right, top, middle, bottom.

1. With the *Tools5* panel open in the workspace, select two of the three buttons on the panel.

Two of the buttons are selected.

2. Select **Align Objects -> Right** from the menu.

The object with the special sizing handles on it is the object that all others will be aligned relative to. The last selected object on the panel is the one in which all others will align to.

Select the other objects and experiment with the Align Objects command.

Match Size

The Match Size command allows you to make one or more objects the same height and width as another selected object.

1. With the *Tools5* panel open in the workspace, resize the tools so each one is a different dimension than all the others on the panel.
2. Select two of the three buttons on the panel. Two of the buttons are selected.
3. Select **Match Size -> Width**.

All buttons are made to match the last selected objects width. Select the other button and experiment with the Match Size command.

Distribute Objects

The Distribute command allows you to space selected objects evenly apart from one another on the panel.

1. With the *Tools5* panel open in the workspace, move the tools so each one is separated from the other buttons on the panel.
2. Select all three buttons on the panel.

All the buttons are selected. You must select at least three buttons for the Distribute command to become available on the menu.

3. Select **Distribute -> Horizontally**.

All selected buttons are spaced evenly within the distance of the right edge of the object located farthest to the right on the panel and the left edge of the leftmost object on the panel.

Orient Objects

The Orient command allows you to change the relationship between a selected graphical object and the panel. Since there are no graphical objects on this panel, the steps are not applicable at this point in the tutorial.

Trend Tool

Use the Trend to display a graph of a collection of tag values over time. Add pens to the trend to define the tag values and how to draw them. Use the trigger settings to specify when to collect the pen data as an

event. Events are collected and held in memory regardless of whether the trend is being viewed. However, events are not retained when the data sources are disconnected or the unit is power cycled.

The following table describes the properties available from the Trend menu.

Property	Description
Name	<p>Enter a unique name for the Trend, up to 32 characters. Names must start with a letter.</p> <p>The default name is Trend, and increments by one with each new trend added.</p>
Values	<p>Under the Values property, you can define the following:</p> <ul style="list-style-type: none"> ■ Trigger Type: Specify whether the trend should collect data based on a Time Interval or Data Change. ■ Trigger Interval: If Time Interval is selected, specify the interval in seconds. ■ Trigger Output: If Data Change is selected, specify the tag to trigger data collection. ■ Displayed Events: Specify the number of data collection events to display on the trend. The allowed range is 1 to 1000. The value of Captured Events may be adjusted automatically to maintain the relationship $\text{Captured Events} \geq \text{Displayed Events}$. ■ Captured Events: Specify the number of data collection events to keep in memory. The allowed range is 1 to 1000. The value of Displayed Events may be adjusted automatically to maintain the relationship $\text{Captured Events} \geq \text{Displayed Events}$.
Pens	<p>Use the pen editor to specify the data points to display in the Trend and how to draw them. For each pen you can specify the following:</p> <ul style="list-style-type: none"> ■ Name: Specify a name for the pen. The name will be displayed in the legend during runtime. ■ Color: Specify the color to use for drawing the pen's value on the trend. ■ Fill: If fill is selected, the area below the graph will be filled in with the color specified. ■ Tag: The tag that defines the value for the pen.

Appearance	<p>The appearance properties let you change the look of the Trend. You can change the style, display area, vertical scale, and horizontal scale.</p> <p>Vertical Scale: The following properties are available for the Vertical Scale:</p> <ul style="list-style-type: none"> ■ Show Scale: Specify whether or not to display the scale. ■ Scale Color: Specify the color to use for drawing the scale text and grid lines. ■ Min Value: Specify the lower limit of the vertical axis. The value of Max Value may be adjusted automatically to maintain the relationship Max Value \geq Min Value. ■ Max Value: Specify the upper limit of the vertical axis. The value of Min Value may be adjusted automatically to maintain the relationship Max Value \geq Min Value. <p>Horizontal Scale: The following properties are available for the Horizontal Scale:</p> <ul style="list-style-type: none"> ■ Show Scale: Specify whether or not to display the scale. ■ Scale Color: Specify the color to use for drawing the scale text and grid lines. ■ Scale Type: Select whether the graph is to use Time or Events as the horizontal axis. ■ Hour Format: If Time is selected, specify 12 or 24 Hour format.
Accessibility	<p>The accessibility properties determine whether or not a tool is visible to all users during Runtime.</p>

Other tools can be used to interact with the trend through connections. The following connections are available for use with a Trend tool.

Connection	Description
PageBack	Use this connection with a Momentary Button tool to allow the operator to shift the display to older data. The amount of data available is limited by the number of Captured Events.
PageForward	Use this connection with a Momentary Button tool to allow the operator to shift the display to newer data. The amount of data available is limited by the number of Captured Events.
Back	Use this connection with a Momentary Button tool to allow the operator to shift the display to oldest data. The amount of data available is limited by the number of Captured Events.
Front	Use this connection with a Momentary Button tool to allow the operator to shift the display to newest data. The amount of data available is limited by the number of Captured Events.
Pause	Use this connection with a Maintained Button tool to allow the operator to freeze/unfreeze the current display.

HorizontalZoom	Use this connection with a Numeric Entry tool to allow the operator to specify the number of events drawn on the graph. The allowed range is 1 to 1000. Any entries outside that range will be ignored by the Trend.
VerticalMax	Use this connection with a Numeric Entry tool to allow the operator to specify the upper limit of the vertical axis. The value of VerticalMin may be adjusted automatically to maintain the relationship $\text{VerticalMax} \geq \text{VerticalMin}$.
VerticalMin	Use this connection with a Numeric Entry tool to allow the operator to specify the lower limit of the vertical axis. The value of VerticalMax may be adjusted automatically to maintain the relationship $\text{VerticalMax} \geq \text{VerticalMin}$.
ShowLegend	Use this connection with a Maintained Button tool to allow the operator to show/hide the legend.

Using Keyboard Shortcuts

Keyboard shortcuts, or hotkeys, are available to help you create panels quickly and easily. To use a keyboard shortcut, simply press the indicated key. If the shortcut includes two keys such as CTRL + 1, do NOT enter "+" sign. Hold down the CTRL key and press the 1 key at the same time. The table below lists all of the Interact Xpress keyboard shortcuts used in the Design environment.

Key	Definition
Delete	Deletes the selected object. Available only in the Panel editor.
Home	Go to the Shell environment.
Shift	Display the grid lines, only while the Shift key is pressed. Available only in the Panel editor.
D	Displays a red dashed line to show where the panel ends when viewed on a 4:3 display.
F	Toggles full screen mode. Pressing the "F" key a second time returns the display to a normal view.
G	Toggles the grid and enables an object to snap to a grid point. Pressing the "G" key a second time removes the grid from the workspace. Available only in the Panel editor.
P	Opens the properties pop-up window for the currently selected object.
Z	Toggles zoom mode. Pressing the "Z" key a second time returns the object to normal size. Available only in the Panel editor.
F1	Opens the context-sensitive, online help system in a separate browser window. Available only in the Design environment.
F2	Enters the test Runtime environment.
Alt + click	Allows you to edit the label on an object. Available only in the Panel editor.
Ctrl + ?	Opens the context-sensitive, online help system in a separate browser window.
Ctrl + 1	Displays the Project editor workspace.
Ctrl + 2	Displays the Panel editor workspace.

Ctrl + 3	Displays the Tag editor workspace.
Ctrl + 4	Displays the Alarm editor workspace.
Ctrl + 5	Displays the Recipe editor workspace.
Ctrl + 6	Displays the Messages editor workspace.
CTRL + A	Selects all of the objects in the workspace. Available only in the Panel editor.
Ctrl + C	Copies an object. Available only in the Panel and Project editors.
CTRL + J	Opens the Style menu when an object is highlighted. Available only in the Panel editor.
CTRL + T	Opens the Input Tag menu when an input tool is highlighted or the Output Tag menu when an output tool is highlighted. Available only in the Panel editor.
Ctrl + V	Pastes an object. Available only in the Panel and Project editors.
Ctrl + Y	Use this command to reverse the Undo command and return the object to the state it was in before pressing Undo. This is only available in the Panel editor.
Ctrl + Z	Use this command to reverse or undo the last action performed on an object in the Panel editor.
Ctrl + resize object	Object retains aspect ratio as it is resized.
Ctrl + Shift + click	Adds points to graphic objects (lines/polygons).
Ctrl + Shift + click on existing point	Deletes points from point objects (lines/polygons).
Ctrl + Enter	Starts a new line while editing text (lens/texts)
Shift + move object	Snaps the object to the grid.
Shift + move point	When using Lines or Polygons, this snaps a point to the grid.
Shift + rotate	Rotates the object in 15 degree increments.

This completes the tools tutorial.

CHAPTER 7: Working With Graphics



Working with Graphics

This chapter is a tutorial that assists you in becoming familiar with developing Interact Xpress Manager panels with a small number of graphics. You also gain experience configuring all the available animation connections.

The tutorial will take about one hour to complete. It exposes you to most of the graphic objects and a majority of their properties. It is recommended that you perform these steps to boost your knowledge of Interact Xpress Manager.

Do not skip steps as each section of the tutorial builds upon previous sections. The project you are developing will work successfully only if the steps are followed as described and in the order in which they are presented.

This tutorial assumes you are using the Offline interface to create this project. You can use a browser to connect to a remote Interact Xpress Manager unit and perform the tutorial as well. To start the designer from your browser, enter the URL of the Interact Xpress Manager machine in your browser's address bar. Interact Xpress Manager is displayed. Other than launching Interact Xpress Manager within your browser, all other steps described below can be accomplished either through Offline or your browser.

You will accomplish the following objectives within this tutorial:

- Create a new project and panel
- Draw graphical objects on the panel
- Apply various animation connections to graphical objects

Interact Xpress Manager panels are saved automatically, therefore as you progress through the tutorial, you will not have to perform any save operation as this is accomplished for you. This is another of the many great features of Interact Xpress Manager.

Creating a New Project

The first step in developing a Interact Xpress Manager application is to create a new project.

1. Launch Interact Xpress Manager from your workstation by selecting the Interact Xpress Manager icon  from your desktop.

Interact Xpress Manager launches and displays the welcome screen.

2. Select the **New**  icon from the local pane.

The New Project dialog appears.

3. Enter a name for your project such as *Graphics Tutorial*.

The project is created and displays an icon within the local pane. The project launches within the workspace and Shell appears as shown below.

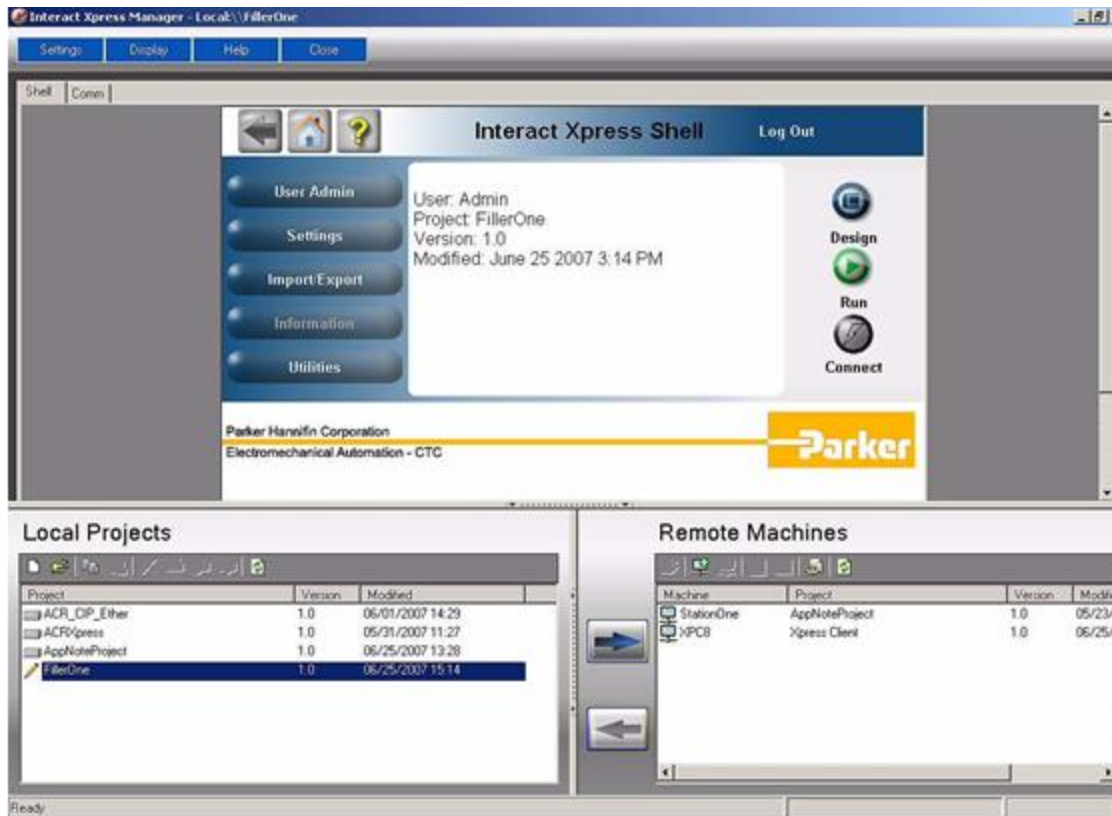

Creating a New Panel

A project consists of many items, such as driver configurations, panels, message files, etc. The next step in developing your project is to create panels.

1. With the *Graphics Tutorial* project loaded in the workspace, maximize the window or browser so that you can see the entire workspace.

2. Select the **Design**  button.

The Interact Xpress Manager Designer launches within the workspace.

3. Within the Interact Xpress Manager Designer, select the **New** command from the menu.

The New fly-out appears.

4. Select **Panel** and enter a name for the panel in the Panel text box as shown below. Name the panel *Graphics1*.



5. Press **Enter** to save the panel and open the Panel Editor. You can also select the checkmark in the upper right of the fly-out.

A blank panel appears. You are now ready to begin configuring your panel.

Adding Navigation Tools to a Panel

Panels can consist of tool and graphic objects. Follow these steps to add the following tools to your panel.

- Maintained button
- Exit button

When adding tools to your panel, you may wish to resize the tool in order to leave adequate space on your panel for further panel development.

The final panel, *Graphics1*, should appear similar to the figure below. An explanation of how to add the controls is described below.

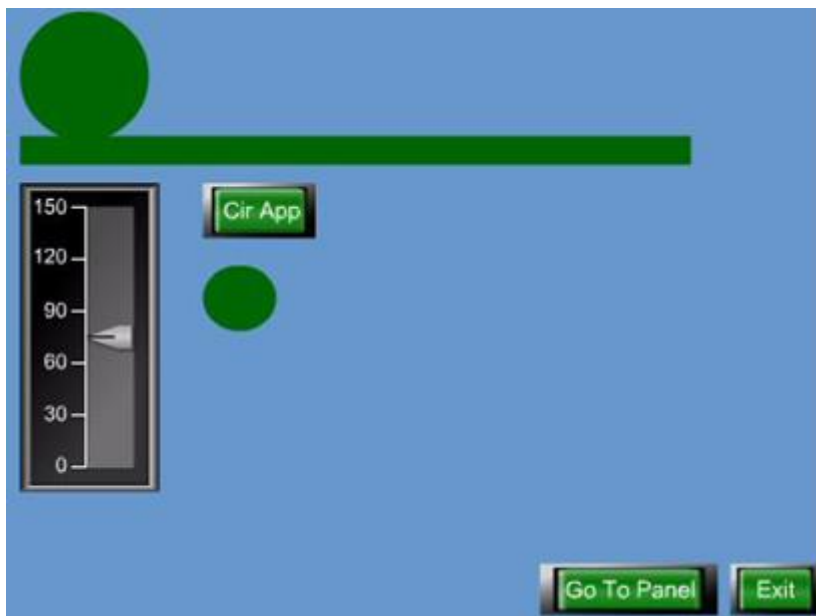

Adding the tool:

1. With the *Graphics1* panel open, select and drag the button from the toolbin onto the panel.

A button is created on the panel. Resize the button. The toolbin is shown below.



2. Place the button in the lower right corner of the panel by selecting the button and dragging it into place

Moving the tool:

- When an object is selected, selection handles appear on the object. An object can be moved anytime its selection handles appear.

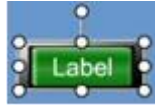

Sizing the tool:

- To resize an object, simply select the object, move the cursor over one of the selection handles, the cursor will change into an arrow, then move the selected handle and resize the object as desired.

Configuring the Maintained button:

With an object selected on the panel, the menu reflects all the properties and commands associated with the selected object.

- Select each property from the menu and configure the settings as listed in the table below.

There are properties with each tool that are not listed in the table below. Leave those properties at their defaults, only change those properties listed below. You may explore the other properties if you wish.

Using the Property heading in the table, select the first property, such as *Appearance*, this will either display a fly-out menu or a secondary menu with further selections. From the fly-out or secondary menu you select the second property such as *Off Lens*.

A typical secondary menu is shown below. All secondary menus have an arrow in the upper left corner that, when selected, will take you back to the upper level menu. Therefore, selecting the left arrow in the Off Lens menu shown below returns you to the main menu.



Button Properties	Setting
Type	Goto Panel
Values - Panel - New Panel	Graphics2

Appearance - Off Lens -Edit Text	Go To Panel
Appearance - Off Lens -Font Size	10
Appearance - Off Lens -Apply to All	Select this

Adding and Configuring an Exit button:

1. With the *Graphics1* panel open, select and drag the button from the toolbin onto the panel.
A button is created on the panel.
2. Place the button in the lower right corner of the panel to the left of the other button as shown in the figure on page 8-3. Adjust the size of the button as necessary.
3. Select each property from the menu and configure the settings as listed in the table below.

Exit Button Properties	Setting
Type	Exit
Exit Button Properties	Setting
Appearance - Off Lens -Edit Text	Exit
Appearance - Off Lens -Font Size	10
Appearance - Off Lens -Apply to All	Select this

Drawing and Manipulating Graphic Objects

You will now place each type of graphic object on the panel and manipulate the graphic.

To add a line plus add and delete points:

1. Select the line object from the toolbin and drag it onto the panel. A line object is created on the panel.
2. With the line object selected, press and hold the **Ctrl+Shift** keys.
The cursor changes into a + symbol. A grid appears on the panel. The grid is used to precisely place nodes for lines and polygons.
3. Click anywhere near the line.
A point is added to the line. Continue to click and press the **Ctrl+Shft** key combination and additional line points are created.
4. Move the cursor over a point, press and hold the **Ctrl+Shift** keys. The cursor changes into a - symbol.

-
5. Click on the point. As long as there are more than two points on the line, clicking on the point deletes it from the line. The remaining points on the line will remain connected.

To add a polygon plus add and delete points:

1. Select the polygon object from the toolbar and drag it onto the panel.
A polygon object is created on the panel.
2. With the polygon object selected, press and hold the **Ctrl+Shift** keys.
The cursor changes into a + symbol.
3. Click anywhere near the polygon.
A point is added to the polygon. Continue to click and press the **Ctrl+Shift** key combination and additional polygon points are created.
4. Move the cursor over a point, press and hold the **Ctrl+Shift** keys. The cursor changes into a - symbol.
5. Click on a point.
As long as there are more than three points on the polygon, clicking on the point deletes it from the polygon. The remaining points on the polygon will remain connected, reshaping the polygon.

To add a rectangle plus constrain the object as a square:

1. Select the rectangle object from the toolbar and drag it onto the panel.
A rectangle object is created on the panel.
2. With the rectangle object selected, move the cursor over one of the four corners of the rectangle object.
3. Press and hold the **Ctrl+Alt** keys.
The cursor changes into a double-headed arrow. As you move the corners of the rectangle, resizing the rectangle, it is constrained into a square.
Selecting a point other than a corner point, then resizing the rectangle will not constrain the shape of the object.
Release the **Ctrl+Alt** keys.
Resizing the rectangle will only constrain its shape if the **Ctrl+Alt** keys are pressed.

To add an ellipse plus constrain the object as a circle:

1. Select the Ellipse object from the toolbar and drag it onto the panel. An ellipse object is created on the panel.

2. With the ellipse object selected, move the cursor over one of the four corners of the ellipse object.

- 3 Press and hold the **Ctrl+Alt** keys.

The cursor changes into a double-headed arrow. As you move the corners of the ellipse, resizing the ellipse, it is constrained into a circle.

Release the **Ctrl+Alt** keys.

Resizing the rectangle will only constrain its shape if the **Ctrl+Alt** keys are pressed.

To add an arc:

1. Select the arc object from the toolbin and drag it onto the panel. An arc object is created on the panel.
- 2 Resize the arc object by moving the cursor over one of the four corners of the arc object.

The arc can be constrained in size using the same method as described for the other graphic objects (Ctrl+Alt key combination).

To add a text object:

1. Select the text object from the toolbin and drag it onto the panel. A text object is created on the panel.
- 2 Resize the text object by moving the cursor over one of the four corners of the text object.

The text can be constrained in size using the same method as described for the other graphic objects (Ctrl+Alt key combination).

Delete the graphic objects on the Graphics1 panel by selecting them all:

1. Press and hold the left mouse button as you drag the mouse across all the graphic objects on the panel.

As you drag the mouse, a rubber-band appears across all the graphic objects.

Each selected object will appear with selection handles. Make sure you have not selected the Exit or Go To Panel buttons. If you have, click off the selected objects and rubber-band through the graphic objects, again, ensuring you do not select either of the button tools.

2. Press **Delete**.

All graphic objects are deleted from the panel.

Animating the Graphics1 Panel

You will now create a simple animated panel containing graphical objects. You will experiment with location and appearance connections.

The final panel you are creating will look like the figure on page 8-3.

Configuring Location and Appearance Connections:

1. Select the Rectangle object from the toolbin and drag it onto the panel and place it in the upper left corner. Make the rectangle stretch across the panel. Refer to the figure on page 8-3.

A Rectangle object is created on the panel.

2. Select the Ellipse object from the toolbin and drag it onto the panel and place it in the upper left corner. Place the Ellipse on top of the Rectangle as if it were laying on a conveyor. Refer to the figure on page 8-3.

An Ellipse object is created on the panel.

3. With the Ellipse object selected, select **Animations -> New -> Appearance**.

An appearance animation is created for the Ellipse object. The menu displays properties associated with the appearance connection.

4. Select each property from the Appearance menu and configure the settings as listed in the table below.

Ellipse Appearance Properties	Setting
Name	cirapp1
Output Tag	cirapp1tag
Color1	Select Red from the Color1 palette.

You have now configured an appearance animation. When the value at *cirapp1tag* goes high, the appearance animation is applied. The ellipse object will then change color from it's present state to Red.

5. With the Ellipse object still selected, click the left arrow located in the upper left corner of the menu.

The Ellipse object menu appears. From this menu, select another animation as described in the following steps.

6. Select **Animations -> New -> Location**.

A location animation is created for the Ellipse object. The menu displays properties associated with a location connection.

Ellipse Location Properties	Setting
Name	cirloc1

Output Tag	cirloc1tag
Start Value	0
End Value	150
Path Roundness	0

7. Select each property from the Location menu and configure the settings as listed in the table below.

Notice that there are nodes created for each point on the location path. The number next to each node represents the location of the graphic object based on the value read from the *cirloc1tag* address.

8. Select the node associated with the End Value (150) and stretch the node so that it ends at the end of the rectangle.

Make sure you select directly on the node or you will return to the Rectangle properties menu. If that occurs, reselect the rectangle, then select **Animations -> cirloc1**, to view the animation properties.

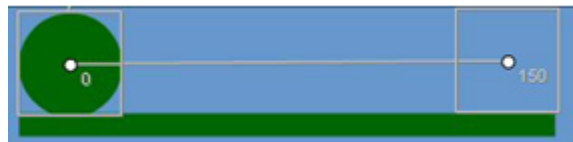

9. Select the Button and Slider tools from the toolbin and drag them onto the panel. Place them below the Rectangle/Ellipse objects.
10. Select each property from the Button and Slider menus and configure the settings as listed in the tables below.

Button Properties	Setting
Type	Momentary
Values - Switch Input	cirapp1tag
Values - Lens Output	cirapp1tag
Appearance - Off Lens -Edit Text	Cir App
Appearance - Off Lens -Font Size	10
Appearance - Off Lens -Apply To All	Select it

Slider Properties	Setting
Values - Slide Input	cirloc1tag
Values - Slide Output	cirloc1tag
Values - Min Value	0
Values - Max Value	150

Testing the Graphics1 Panel in Run Mode

Once the panel has been developed you can now test it in runtime. You can quickly enter test runtime to test the functionality of your application.

1. Select the **Test Runtime**  icon in the Designer. You enter test runtime.
2. Select the maintained button and notice that the Ellipse graphic reflects the *cirapp1tag* bit's change of state.
3. Select the **Slider** and move the knob position up and down the Slider tool.
As you move the knob, the data changes at the *cirloc1tag* which causes the Ellipse to move across the rectangular conveyor.
4. Select the **Exit Run Mode** button and you are returned to the Designer.

Adding another Location Animation

You will now add another Ellipse object with a location animation.

1. Select the Ellipse object from the toolbin and drag it onto the panel. Place the Ellipse below the rectangle. Refer to the figure on page 8-3.
An Ellipse object is created on the panel.
2. With the Ellipse object selected, select **Animations -> New -> Location**.
A location animation is created for the Ellipse object. The menu displays properties associated with a location connection.
3. With the Ellipse object selected, press and hold the **Ctrl+Shift** key combination then click along the location path to add additional nodes.

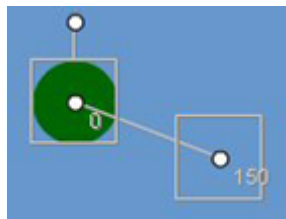

Each time you click the location path, a node is added to the path with a number displayed above each node. This number represents the location of the graphic object based on the value read from the *cirloc1tag* address. Add as many nodes as you wish. There is no specific path you need to create, be creative!

You must continue to press and hold the **Ctrl+Shift** key combination in order to add the nodes to the path.

4. Release the **Ctrl+Shift** key combination after you have added all the nodes you wish.
5. After the path is created, you can click a node and move it around the panel to achieve the desired location animation path.

Refer to the figure below for a sample path you may create.

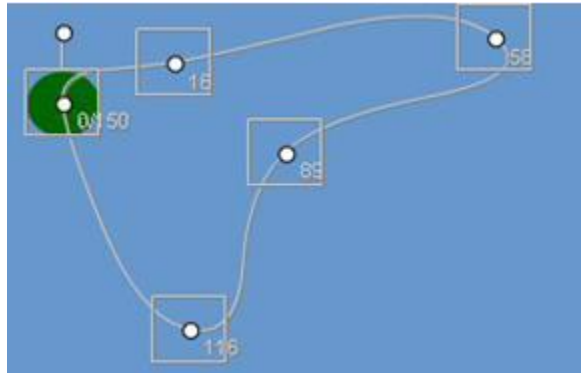

6. Select each property from the Location menu and configure the settings as listed in the table below

Ellipse Location Properties	Setting
Name	cir2loc1
Output Tag	cirloc1tag (same address as the first Ellipse location animation)
Start Value	0
End Value	150
Path Roundness	100 - Notice that the nodes become rounded.
Closed Path	Select it - Notice that the path end node overlaps the path beginning node.

Selecting a closed path will complete the location path, bringing the object back to the starting node upon reaching the maximum value.

Testing the Graphics1 Panel with an added Location Animation

1. Select the **Test Runtime**  icon in the Designer.

You enter test runtime.

2. Select the **Slider** and move the knob position up and down the Slider tool.

As you move the knob, the data changes at the *cirloc1tag* which causes the Ellipse to move across the rectangular conveyor. The second Ellipse you just created will follow the path you designated during development.

3. Select the **Exit Run Mode** button and you are returned to the Designer.

Creating the Graphics2 Panel

You will now create a second graphics panel to continue experimenting with additional animation connections.

Configuring the panel navigation buttons

You must first create panel navigation buttons on the Graphics2 panel.

1. With the Graphics1 panel in the project workspace, select both the Exit and Go To Panel buttons.
2. Select **Copy**, go to the panel Graphics2, select **Paste**.

Both the Exit and Go To Panel buttons are pasted onto the Graphics2 panel.

3. Select the Go To Panel button, select **Values -> Panel -> Graphics1**.

You modified the Go To Panel configuration so that during runtime operation, selecting this button will take you to the *Graphics1* panel.

Configuring Size and Appearance Connections

The final panel you will create looks similar to the graphic shown below.

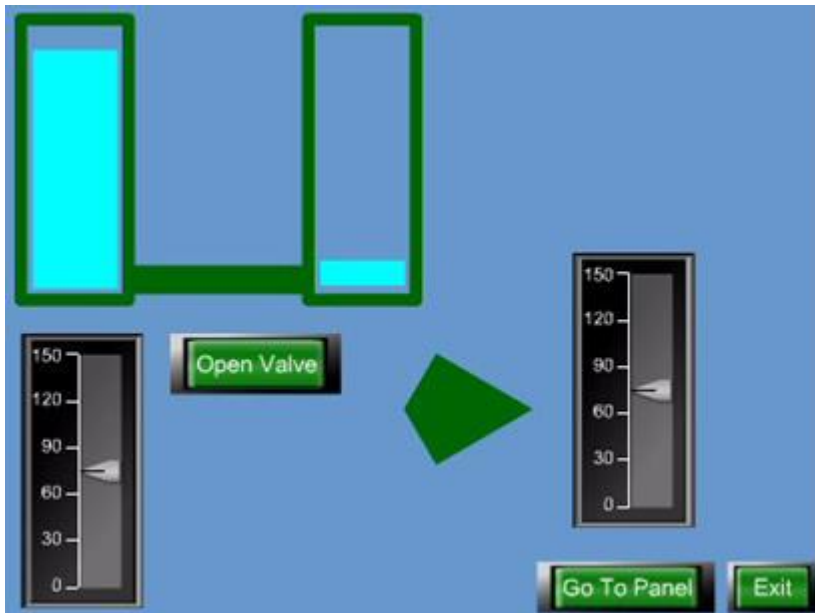

You will use rectangle objects to create tanks and tubing between the tanks. A Slider and Button tool are used to control the flow of fluid between the tanks and to open and close the tube.

In addition, a Polygon will be added to the panel and will contain a rotation animation connection. A second Slider tool will be used to control the rotation and transparency of the Polygon. This activity will firm up your understanding of the remaining animation connections.

1. Select the Rectangle object from the toolbin and drag onto the panel.
2. Select **Style -> Thick Border** from the menu.
3. Select another Rectangle object from the toolbin and drag onto the panel, place the object inside the Rectangle you just created.
4. Resize the inner rectangle so that it fills up the majority of the outer rectangle space. Refer to the figure on page 8-13.
5. With the "inner" rectangle selected, select **Color 1 -> Light Blue** from the menu.
6. With the "inner" rectangle selected, click **Animations -> New -> Size** and configure the settings as listed in the table below.

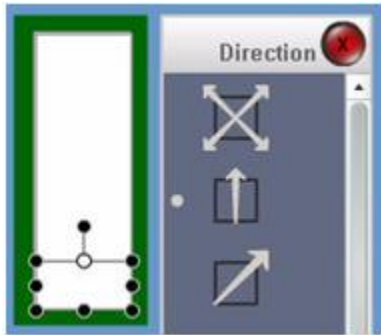
	Setting
Name	tank1size
Output Tag	tank1sizetag
Start Value	0
End Value	150
Direction	<p>Select the arrow pointing up. The inner rectangle will be selected. Move the highlighted point (white colored) down. This is the size of the rectangle at the End Value, as if the tank were almost empty.</p> 

7. Select both the "outer" and "inner" rectangles by holding down the **Ctrl** key as you select them.
8. Select the **Copy** button then the **Paste** button. The tank is copied onto the panel.
9. Place the tank to the right of the first tank.

10. After placing the tank to the right of the panel, select only the “inner” rectangle of the pasted tank.
11. Change the size of the “inner” rectangle so that it appears almost “empty”. Refer to the figure on page 8-13.

You will change the sizing direction of this rectangle, leaving all other properties the same as the first tank. Therefore, when the left tank is emptying, the right tank is filling up.

12. Click **Animations** -> **tank1size** and configure the settings as listed in the table below.

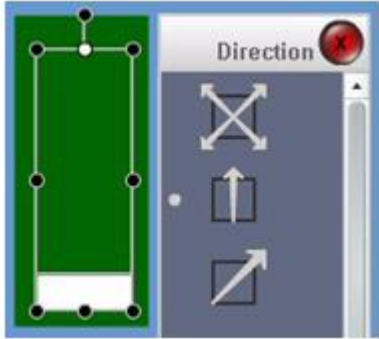
	Setting
Name	tank1size
Output Tag	tank1sizetag
Start Value	0
End Value	150
Direction	<p>Select the arrow pointing up. The inner rectangle will be selected. Move the highlighted point (white colored) up. This is the size of the rectangle at the End Value, as if the tank were almost full.</p> 

Now you will add a rectangle object and create the tubing between the two tanks. Refer to the figure on page 8-13 for a view of the panel

13. Select a rectangle from the toolbin and place it on the panel. Move the rectangle and resize it so that it appears to connect between the two tanks.
14. With the rectangle connecting the two tanks selected, click **Animations** -> **New** -> **Appearance** and configure the settings as listed in the table below.

Rectangle Appearance Properties	Setting
Name	valveopen
Output Tag	valveopentag

Color 1	Light Blue
---------	------------

Now you will add a Slider to control the tank fill and a button to control the valve.

15. Select the Slider and Button tools and drag them onto the panel. Position the Slider and Button both below the tank objects.
16. Select each property from the Button and Slider menus and configure the settings as listed in the tables below.

Button Properties	Setting
Type	Maintained
Values - Switch Input	valveopentag
Values - Lens Output	valveopentag
Appearance - Off Lens -Edit Text	Open Valve
Appearance - Off Lens -Font Size	10
Appearance - Off Lens -Apply To All	Select it

Slider Properties	Setting
Values - Slide Input	tank1sizetag
Values - Slide Output	tank1sizetag
Values - Min Value	0
Values - Max Value	150

Testing the Graphics2 Panel in Run Mode

1. Select the **Test Runtime**  icon in the Designer. You enter test runtime.
2. Select the **Open Value** button.

The rectangle connecting the two tanks changes color.

3. Select the **Slider** and move the knob position up and down the Slider tool.

As you move the knob, the data changes at the *tank1sizetag* which causes the left tank fluid level to decrease at the same time as the right tanks fluid level increases.

4. Select the **Exit** button and you are returned to the Designer.

Configuring Rotation and Transparent Connections

You will now add a polygon and configure it with rotation and transparent animation connections.

1. Select a polygon from the toolbin and place it on the panel. Move the polygon so that it is to the right of the Slider and Button tools. Refer to the figure on page 8-13.
2. Select the polygon and delete some of its points so that it appears as a pointed object.
3. With the Polygon selected, click **Animations -> New -> Rotation** and configure the settings as listed in the table below.

Polygon Rotation Properties	Setting
Name	polyrot
Output Tag	polyrotag
Start Value	0
End Value	150
Direction	Clockwise

4. Click off the Polygon, then reselect it to display the Polygon menu in order to apply the transparency animation.
5. With the Polygon selected, click **Animations -> New -> Transparency** and configure the settings as listed in the table below.

Polygon Transparency Properties	Setting
Name	polytrans
Output Tag	polyrotag - (you are using the same tag to both rotate the object and cause the object to turn transparent)
Start Value	0
End Value	150
Direction	Opaque to Transparent

Now you will add a Slider to control the rotation and transparency of the polygon.

6. Select the Slider tool and drag it onto the panel. Position the Slider next to the polygon object.
7. Select the property from the Slider menu and configure the settings as listed in the table below.

Slider Properties	Setting
Values - Slide Input	polyrotag
Values - Slide Output	polyrotag
Values - Min Value	0
Values - Max Value	150

You are now ready to perform the final test of the Graphics2 panel.

Final Test of the Graphics2 Panel

1. Select the **Test Runtime**  icon in the Designer. You enter test runtime.
2. Select the **Slider** and move the knob position up and down the Slider tool.

As you move the knob, the data changes at the *polyrotag* which causes the Polygon to rotate in a clockwise direction at the same time that it turns transparent.

3. Select the **Exit** button and you are returned to the Designer. This concludes the Graphics animation tutorial.

CHAPTER 8: Using the Tag Editor



Using the Tag Editor

The Tag Editor lets you create and set up new tags, modify tags, delete tags, and validate tags. Any tag you create is referred to as a user-defined tag, to differentiate it from system tags that have predefined functions.

A tag is a variable that is used in place of a controller-specific address or relational expression. Tags reference values from a control machine or an expression of multiple values. You define Panel tools using tags for their input and output references. The Tag Editor is used to associate the tags with controller references. Tags can reference:

- An address reference string from the control machine.
- An internal memory value in the run mode workstation.
- A scaling function or expression made up of other tags and/or controller-specific references.

To learn more, refer to the following:

- The Tag Editor Window
- Creating and Editing Tags
- Deleting Tags
- Validating Tags
- Using System Tags
- Using Expressions
- Using Data Types
- Tag Scaling
- Tag Rules

The Tag Editor Window

The Tag Editor consists of several columns of tag data. You can edit the name and address fields for every tag you create. The edits you make to these fields determine how the tag works in your project. The Tag Editor is shown below.

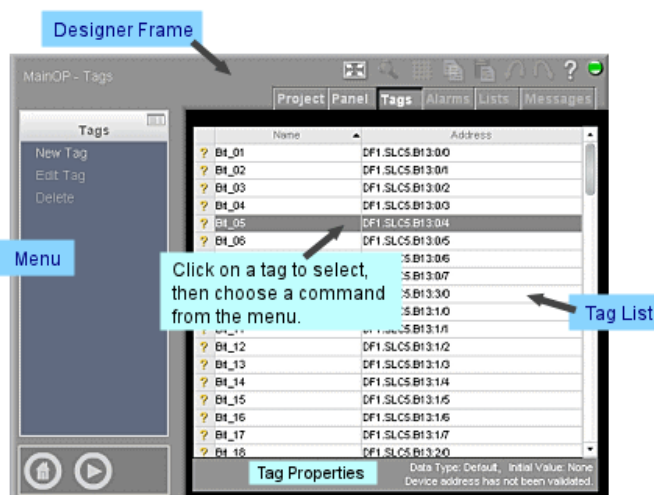

New tags are displayed at the end of the Tag Editor list until you sort the columns. The table below describes the information found in the tag list

Field	Description
Status	<p>The column to the left of the tag name provides a summary of the tag status. Normally, this field is blank. However, an icon may appear here to give a summary of the tag status.</p> <ul style="list-style-type: none"> ■ A dark grey X means that the tag is not currently used in your project, however there are no errors associated with it. ■ A yellow question mark (?) means the machine address has not been validated. Tag validation occurs when you configure the tag in the Tag editor. ■ A red exclamation point (!) means that at least one of the tag fields is in error. <p>Note that a warning does not necessarily mean that there is anything wrong with the tag definition, just that there could be. For example, if a tag is tied to a source that is not available at design time, then a warning appears in the address field specifying that address validation will not be performed.</p>
Name	<p>This column displays the tags currently used in the project. You can edit the names either by highlighting a tag name and selecting Edit Tag from the Tags menu or by double-clicking on a tag name. The Edit Tag screen is displayed. For details on using this screen, refer to Creating and Editing Tags.</p> <p>There are a few restrictions to what can appear in the Name field:</p> <ul style="list-style-type: none"> ■ The first character must be a letter. ■ Names can have up to 32 characters. ■ Names must contain only alphanumeric characters and underscores (_), though they cannot begin with an underscore except for system tags. ■ Tag names must be unique. There cannot be duplicate tag names. ■ Tag names are NOT case sensitive. Therefore, a tag named 'Switch1' is the same as a tag named 'switch1'. <p>Note that the names of system tags are predefined. You cannot modify them. For a list of system tags available in Interact Xpress, refer to System Tags.</p>
Address	<p>An address is the memory location for the tag that is located in the data source. Interact Xpress interprets an empty machine address as a local tag.</p>

Data Transfers

Tag references can occur in panel tools or from the address of another tag. It is important to note that data transfers still occur for tags that are not referenced. For example, if a tag has an address of

`'Ch1.D1.K1' = 'Ch2.D1.K1'`

this transfer still takes place even if no other tool or tag refers to this tag.

A data transfer simply means that when the expression Ch2.D1.K1 changes value, the result is written to Ch1.D1.K1. This happens whether there is a reference to the tag or not. By default, this evaluation is not performed during initialization of the application in runtime.

To configure data transfers to occur during initialization of the application in runtime, check the Perform Initial Data Transfers option located on the applications Runtime Settings menu.

Sorting Tags

New tags are added to the bottom of the Tag Editor list. To sort the tags displayed in the Tag Editor, select the column header you want to sort. Columns are sorted in the following order:

- blank
- numbers 0 - 9
- letters A - Z
- underscores



The Status column sorts in the following order:

- tags in error
- unreferenced tags
- normal tags

Tag and Expression Icons

The following table describes the expression icons used in Interact Xpress.

Field	Description
<p>Connections</p> 	<p>Drops down a list of connections available with the selected tool. For example, you can have a button connected to a recipe and viewer. In Runtime, when the button is pressed a recipe can be sent to recipe viewer and displayed. You can also send the displayed recipe to the Xpress machine, save the recipe with another name, clear the recipe, etc.</p> <p>The connection are listing in the following format:</p> <p><i>Toolname.tag/command</i></p> <p>For example, let's say you have a recipe named "BreadRecipes" in your project. To create a button that send the recipe to the Xpress machine:</p> <ol style="list-style-type: none"> 1. From the Button menu, you would select the Values>Switch Input menu command. The Switch Input box is displayed. 2. Click on the connection Icon. 3. Use the drop down list to select the tag: <i>BreadRecipes.Sendlist</i>. This connects the BreadRecipes recipe to the button you created. <p>During Runtime, pressing this button will send the recipe, (BreadRecipes) to the Xpress machine.</p>

<p>Tag List</p> 	<p>Drops down a list of tags currently used in the project. You can select a user-defined tag or a system tag. Tags are listed in alphabetical order, user-defined tags followed by System Tags.</p>
<p>Functions & Operators List</p> 	<p>Drops down a list of available functions and operations for mathematical, logical, and relational expressions.</p>
<p>Recent Expressions List</p> 	<p>Drops down a list of the 10 most recently entered tags, expressions, and control machine addresses. Select an item in the list to reuse it for the tag assignment.</p>

Creating and Editing Tags

When you define a tool in the Panel editor, you use tags to reference input and output values in the Xpress machine. You also use tags to determine whether a tool is accessible during Runtime. Tags can reference:

- An address reference string from the control machine.
- An internal memory value in the XP PowerStation.
- A scaling function or expression made up of other tags and/or controller-specific references.

Any tag that you create is referred to as a *user-defined tag* in order to differentiate it from system tags that have predefined functions.

A status bar with two lines of information is displayed at the bottom of the Tag Editor. The top line of the status bar lists the data type and initial value of the selected tag. The bottom line of the status bar contains a description of the tag or error information as shown below.

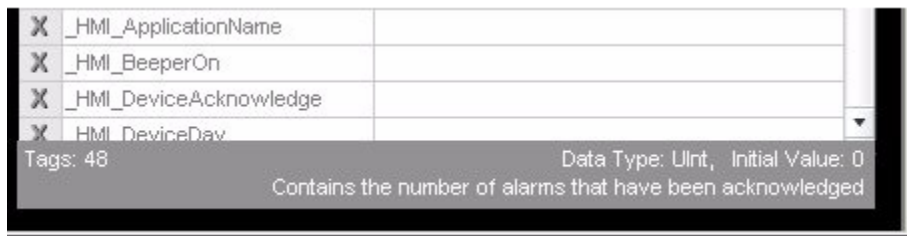

You can select multiple rows of tags by pressing and holding the Ctrl key as you select each tag in the editor.

To Create a Tag

- Select **New Tag** from the Tag Editor menu. The Edit Tag screen is displayed.

To Edit Tag Information

1. From the Tag Editor, highlight the row containing the tag you want to edit. You can also double-click on the row containing the tag.
2. From the menu, select Edit Tag. The Edit Tag screen is displayed.

The Edit Tag Screen

The Edit Tag screen is shown below.

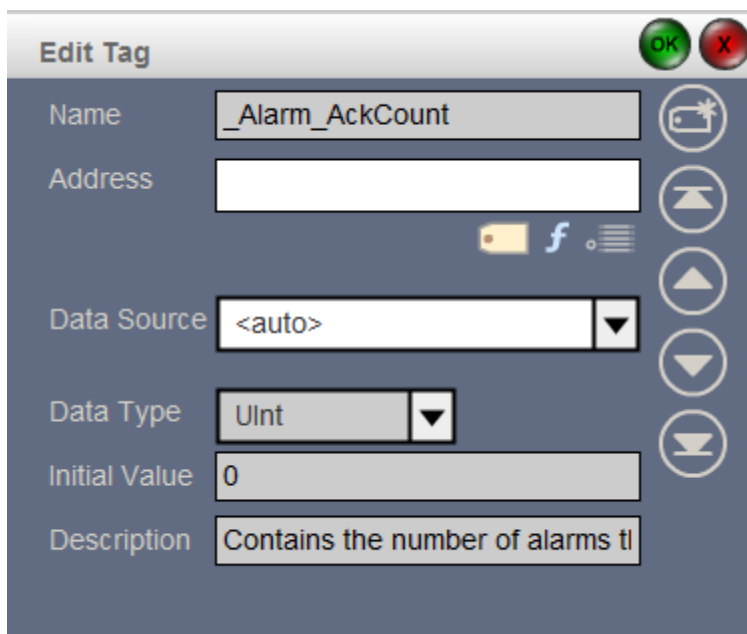

The screenshot shows the 'Edit Tag' dialog box with the following fields and values:

Field	Value
Name	_Alarm_AckCount
Address	
Data Source	<auto>
Data Type	UInt
Initial Value	0
Description	Contains the number of alarms tl



Additional features include a toolbar on the right with icons for OK, X, and navigation (up/down arrows), and a search icon (magnifying glass) next to the Address field.



The following table describes the properties available on the Edit Tag screen.

Field	Description
Name	<p>Enter the name for the new tag within the text box. There are a few restrictions concerning tag naming conventions:</p> <ul style="list-style-type: none"> ■ The first character must be a letter. ■ Names may have a maximum of 32 characters. ■ Names must contain only alphanumeric characters and underscores (_), though they cannot begin with an underscore. ■ Tag names must be unique. There cannot be duplicate tag names. ■ Tag names are NOT case sensitive. Therefore, a tag named 'Switch1' is the same as a tag named 'switch1'. ■ You cannot close the Edit Tag dialog box until all required information is entered and valid.
Address	<p>An address is the memory location for the tag that is located in the data source. Interact Xpress interprets an empty address as a local tag.</p> <p>There are a number of rules for properly addressing tags:</p> <ul style="list-style-type: none"> ■ The Address field can be left blank (in the case of a local tag), directly reference a memory address, or it can be an expression. ■ If referencing a memory address, it will be in the format of: Channel.Device.memory_address ■ Refer to the communications driver used for your project as the exact format is dependent upon the specific driver you are using. ■ The address is validated upon leaving the Edit Tag dialog or otherwise committing the tag. Validation is based on the device driver selected for your project. ■ If the tag has an invalid address, you cannot save and close the Tag Editor window. <p>The standard format for direct addressing a memory address is Channel.Device.m1 , where</p> <ul style="list-style-type: none"> ■ Channel references the communication driver ■ Device references the model of the driver. ■ m1 references the memory address. <p>However, the address format can vary depending on the model and manufacturer of the controller. The address format you use depends on what is expected by your communication driver. For more about defining channels and devices, see the Interact Xpress Manager Help system.</p> <p>Examples of what you can enter in the Address field:</p> <ul style="list-style-type: none"> ■ Sim.PLC.sine(250, 0, 100, 2, 0), where Sim is the channel, PLC is the device, and the numbers in parentheses specify the behavior of the sine function. ■ Channel1.Device1.k100, where k100 is the memory address. <p>Tag scaling is the adjustment of a value using functions or expressions. Tag scaling can occur either at the tool level or in the Tag Editor. See Tag Scaling for a complete description of scaling options.</p>
Data Source	The only choice in Xpress is <auto>.

Data Type	By Default Xpress will use the Data Type of the assigned controller tag. Xpress supports the following types: Bool, Sint, USint, Int, UInt, DInt, UDInt, Real, LReal, String.
Initial Value	<p>Select this field to enter the tag's initial value. If an initial value is specified, it is written to the tag when Interact Xpress is connected, unless the tag is read only. Note that if there are multiple remote users, the initial value is only written when the user puts Xpress in connected mode.</p> <p>If an initial value is not specified, Interact Xpress initializes the tag to the value stored in the tag address at startup.</p> <p>There are several issues to consider when determining an initial value for your project.</p> <ul style="list-style-type: none"> ■ Initial values can be left blank, a numeric value, or a string value. ■ Initial values are based on the tag's type. For example, a BOOL tag may have an initial value of either On/True (non-zero) or Off/False (zero). ■ Initial values can contain constants such as PI and E. ■ Validation is dependent upon the device driver used with this project and the memory address assigned. ■ Validation will occur when you select the OK button or the New Tag icon on the Edit Tag dialog. <p>If nothing is specified in the initial value field, the address is read and the tag is initialized with that value.</p> <p>For more information, see Checking Tag Data for Errors.</p>
Description	<p>Select this field to enter a description of the tag. For system tags, this field provides a brief description of the tag's functionality.</p> <p>The Description field has an 80 character maximum limit.</p> <p>More information about individual system tags is available in the System Tag reference.</p>

The following table defines the controls used on the Edit Tag screen.

Field	Description
Create a New Tag 	Saves the current tag properties, then initializes the fields to create a new tag.
Goto First Tag 	Displays the properties for the first tag in the Tag List.
Goto Previous Tag 	Displays the properties for the previous tag in the Tag List.

Goto Next Tag 	Displays the properties for the next tag in the Tag List.
Goto Last Tag 	Displays the properties for the last tag in the Tag List.

Deleting Tags

To delete tag information:

1. Select the tag you want to delete in the Tag Editor.
2. Select the Delete command from the Tags menu. The tag is deleted from your project.

Note: Be sure you want to delete the tag. Unless the tag is referenced or in error, there is no prompt asking if you really want to delete it. However, if you accidentally delete a tag, you can use the Undo command to restore it.

Validating Tags

Interact Xpress validates tags as they are entered in the Designer. There are three types of tag validation.

- Tag syntax checking
- Control device address validation
- Initial value validation

For tag expression rules and examples, refer to Tag Scaling.

Syntax Checking

Tag syntax is checked at the time the tag is committed (or saved). This occurs any time you enter a tag in a tool or when using the Tag editor. You commit the tag for validation by selecting the OK button in the dialog box or by pressing the Enter key. Within the Tag Editor, the syntax is checked whenever you leave the Name field within the Edit Tag dialog box.

Interact Xpress checks for proper tag naming and expression syntax. Tag naming rules are listed below:

- The first character must be a letter.
- Names can have a maximum of 32 characters.
- Names can contain alphanumeric characters and underscores.

If a tag syntax error is detected, a message is displayed on the address flyout for the object that indicates what the error is, and the cursor is placed within the entry field at the point where the error was encountered.

For any tag syntax error, an icon appears over the tool in error. If entering the tag through the Edit Tag dialog, the Tag editor cannot be saved and closed if the address contains a syntax error.

Control Device Address Checking

The format of a tag address is validated whenever you try to commit (or save) the tag. Interact Xpress checks for proper control device validation dependent upon the addressing rules for the particular control device.

On the Xpress machine, if an error is detected in a tag address, an icon appears in the status column of the Tag Editor.

To determine the addressing rules for a particular driver, refer to the online help for the driver of interest.

Tag Initialization

Initial value validation occurs when you commit the tag within the Edit Tag dialog. Interact Xpress checks the initial value against the Data Type selected. If the Data Type is set to default, the initial value remains what the user entered. If the initial value is within range for the specified data type, Interact Xpress retains the value. If the initial value is out of range for the specified data type, the field changes to blank.

If an initial value is specified, it is written to the tag when Interact Xpress is first connected, unless the tag is read only. If an initial value is not specified, Interact Xpress initializes the tag to the value stored in the control machine at startup.

- Additional initial value rules are listed below:
- The initial value for local tags is 0 or empty.
- The default initial value of any tag is blank.
- Blank initial values will remain blank if you change the data type.
- Initial values you set to 0 will remain 0 if you change the data type.

The following table shows some examples of tag initialization.

Name	Address	Initial Value	Result
Tag2	K2 * 2	25	Tag2 will initialize to the value of K2*2 and not to 25.
Tag6	empty	0	Tag6 will initialize to 0 (or empty if a string).

Initial Data Transfers

Upon entering Runtime, if the Perform Initial Data Transfers option is checked in the Runtime Settings menu, then the data currently at the referenced address is read from the controller when Interact Xpress is first connected. If the Perform Initial Data Transfers option is not selected, then no read transfer will occur upon Xpress first entering Runtime.

After initially entering Runtime, read data will only be transferred to the Xpress unit upon a data change in the control machine.

Using System Tags

The following is a description of tags supplied with Interact Xpress. The tags are listed in alphabetical order, tags that are highlighted are available on the local client only.

Tag	Description
_Alarm_AckAlarms	Use this system tag to acknowledge all alarms, except those requiring individual acknowledgment, in the Alarm Summary. Type: Boolean Initial Value: FALSE Access: Read/Write
_Alarm_AckCount	Use this system tag to display the number of alarms that have been acknowledged. Type: UInt Initial Value: 0 Access: Read Only
_Alarm_ActiveCount	Use this system tag to display the number of alarms currently active. Type: UInt Initial Value: 0 Access: Read Only
_Alarm_AudibleControl	Use this system tag to enable and disable the audible alarm tone. Type: Boolean Initial Value: TRUE Access: Read/Write
_Alarm_BackupLog	Use this system tag to initiate the backup operation of all logs. Type: Boolean Initial Value: FALSE Access: Read/Write

_Alarm_ClearAlarms	<p>Use this system tag to remove the inactive alarms. Those requiring acknowledgment must be highlighted before being removed.</p> <p>Type: Boolean</p> <p>Initial Value: FALSE</p> <p>Access: Read/Write</p>
_Alarm_ClearLog	<p>This system tag will clear all logged items upon going TRUE.</p> <p>Type: Boolean</p> <p>Initial Value: FALSE</p> <p>Access: Read/Write</p>
_Alarm_Errors	<p>Use this system tag to display errors processing alarms.</p> <p>Type: String</p> <p>Initial Value: N/A</p> <p>Access: Read Only</p>
_Alarm_HighestPriority	<p>Use this system tag to indicate the highest priority (1-5) of all active alarms.</p> <p>Type: UInt</p> <p>Initial Value: 0</p> <p>Access: Read Only</p>
_Alarm_LoggingControl	<p>Use this system tag to enable and disable alarm logging. This tag also allows you to set the initial values.</p> <p>Type: Boolean</p> <p>Initial Value: TRUE</p> <p>Access: Read/Write</p>
_Alarm_LogMessage	<p>Use this system tag to write a message to the alarm log.</p> <p>Type: String</p> <p>Initial Value: N/A</p> <p>Access: Read/Write</p>

_Alarm_UnackCount	<p>Use this system tag to indicate the number of alarms that have not been acknowledged, both active and inactive.</p> <p>Type: UInt</p> <p>Initial Value: 0</p> <p>Access: Read only</p>
_HMI_DeviceAcknowledge	<p>Use this system tag to reflect the current state of the _HMI_DeviceWatchdog system tag.</p> <p>Type: Boolean</p> <p>Initial Value: 0</p> <p>Access: Read only</p>
_HMI_DeviceDay	<p>Use this system tag to display the current day of the week while in run mode. For example if today is July 19, 2006, the tag contains 19. The tag reads the day from the assigned machine location.</p> <p>Type: UInt</p> <p>Initial Value: 0</p> <p>Access: Read only</p>
_HMI_DeviceHour	<p>Use this system tag to display the current hour while in run mode. For example if the time is 4:19 PM, the tag contains 04. The tag reads the hour from the assigned machine location.</p> <p>Type: UInt</p> <p>Initial Value: 0</p> <p>Access: Read only</p>
_HMI_DeviceMinute	<p>Use this system tag to display the current minute while in run mode. For example if the time is 4:19 PM, the tag contains 19. The tag reads the minute from the assigned machine location.</p> <p>Type: UInt</p> <p>Initial Value: 0</p> <p>Access: Read only</p>

_HMI_DeviceMonth	<p>Use this system tag to display the current month while in run mode. For example if today is July 19, 2005, the tag contains 04. The tag reads the month from the assigned machine location.</p> <p>Type: UInt</p> <p>Initial Value: 0</p> <p>Access: Read only</p>
_HMI_DeviceSecond	<p>Use this system tag to display the current second while in run mode. For example if the time is 04:19:23, the tag contains 23. The tag reads the seconds from the assigned machine location.</p> <p>Type: UInt</p> <p>Initial Value: 0</p> <p>Access: Read only</p>
_HMI_DeviceTimeoutError	<p>Use this system tag to indicate that the system tag _HMI_DeviceAck did not reflect the expected state within the timeout period.</p> <p>Type: Boolean</p> <p>Initial Value: 0</p> <p>Access: Read/Write</p>
_HMI_DeviceTimeSync	<p>Use this system tag to set the server time/date to values read from the assigned machine time/date system tags when TRUE.</p> <p>Type: Boolean</p> <p>Initial Value: FALSE</p> <p>Access: Read/Write</p>
_HMI_DeviceWatchdog	<p>Use this system tag to monitor a specific machine input. This tag toggles the state of a bit at a specified rate.</p> <p>Type: Boolean</p> <p>Initial Value: 0</p> <p>Access: Read/Write</p>

_HMI_DeviceYear	<p>Use this system tag to display the current year while in run mode. For example if today is July 19, 2006, the tag contains 2006. The tag reads the year from the assigned machine location.</p> <p>Type: UInt</p> <p>Initial Value: 0</p> <p>Access: Read only</p>
_HMI_Exit	<p>Use this system tag to exit your run mode session.</p> <p>Type: Boolean</p> <p>Initial Value: FALSE</p> <p>Access: Read/Write</p>
_HMI_ProjectName	<p>Use this system tag to assign a project name to your application.</p> <p>Type: Boolean</p> <p>Initial Value: FALSE</p> <p>Access: Read/Write</p>
_HMI_RegionCode	<p>Use this system tag to change the region settings (including language) to the specified region code.</p> <p>Type: DINT</p> <p>Initial Value: 0</p> <p>Access: Read/Write</p>
_HMI_ScreenlightOn	<p>Use this system tag to show the current state of the display screenlight.</p> <p>Type: Boolean</p> <p>Initial Value: FALSE</p> <p>Access: Read/Write</p>
_HMI_ScreenlightOverride	<p>Use this system tag to override the current state of the screenlight.</p> <p>Type: Boolean</p> <p>Initial Value: FALSE</p> <p>Access: Read/Write</p>

<p>_HMI_SystemDay</p>	<p>Use this system tag to display the day of the week while in run mode. For example if today is July 19, 2006, the tag contains 19. The tag reads the day from the settings in your run mode workstation.</p> <p>Type: UInt</p> <p>Initial Value: 0</p> <p>Access: Read only</p>
<p>_HMI_SystemHour</p>	<p>Use this system tag to display the hour while in run mode. For example if the time is 4:19 PM, the tag contains 04. The tag reads the hour from the settings in your run mode workstation.</p> <p>Type: UInt</p> <p>Initial Value: 0</p> <p>Access: Read only</p>
<p>_HMI_SystemMinute</p>	<p>Use this system tag to display the minute while in run mode. For example if the time is 4:19 PM, the tag contains 19. The tag reads the minute from the settings in your run mode workstation.</p> <p>Type: UInt</p> <p>Initial Value: 0</p> <p>Access: Read only</p>
<p>_HMI_SystemMonth</p>	<p>Use this system tag to display the month while in run mode. For example if today is July 19, 2005, the tag contains 07. The tag reads the month from the settings in your run mode workstation.</p> <p>Type: UInt</p> <p>Initial Value: 0</p> <p>Access: Read only</p>
<p>_HMI_SystemSecond</p>	<p>Use this system tag to display the seconds while in run mode. For example if the time is 04:19: 23, the tag contains 23. The tag reads the seconds from the settings in your run mode workstation.</p> <p>Type: UInt</p> <p>Initial Value: 0</p> <p>Access: Read only</p>

_HMI_SystemYear	<p>Use this system tag to display the year while in run mode. For example if today is July 19, 2005, the tag contains 2005. The tag reads the year from the settings in your run mode workstation.</p> <p>Type: UInt</p> <p>Initial Value: 0</p> <p>Access: Read/Write</p>
_InputList_SendByName	<p>Use this system tag to send the specified Recipe to the machine.</p> <p>Type: String</p> <p>Initial Value: N/A</p> <p>Access: Read/Write</p>
_InputList_SendByNumber	<p>Use this system tag to send the specified Recipe to the machine.</p> <p>Type: Fine Integer</p> <p>Initial Value: N/A</p> <p>Access: Read/Write</p>
_Panel_AutoScrollEnable	<p>Use this system tag to Enable/Disable automatic panel scrolling (TRUE=Enabled)</p> <p>Type: Boolean</p> <p>Initial Value: 1</p> <p>Access: Read/Write</p>
_Panel_AutoScrollTime	<p>Use this system tag to set the time in seconds for automatic panel scrolling</p> <p>Type: UDINT</p> <p>Initial Value: 0</p> <p>Access: Read/Write</p>
_Panel_BackPanel	<p>Use this system tag to display the last panel loaded in the Runtime environment. When the new panel opens, the current panel closes.</p> <p>Type: Boolean</p> <p>Initial Value: FALSE</p> <p>Access: Read/Write</p>

_Panel_CurrentPanel	<p>Use this system tag to hold the index number of the current panel displayed in the Runtime environment.</p> <p>Type: UInt</p> <p>Initial Value: 0</p> <p>Access: Read only</p>
_Panel_GoToPanel	<p>Use this system tag to jump to another panel in the Runtime environment. When the new panel opens, the current panel closes.</p> <p>Type: UInt</p> <p>Initial Value: 0</p> <p>Access: Read/Write</p>
_Recipe_LastRecipeSent	<p>Use this system tag to display the name of the last recipe downloaded.</p> <p>Type: String</p> <p>Initial Value: N/A</p> <p>Access: Read/Write</p>
_Recipe_RecipeStatus	<p>Use this system tag to display the status messages related to recipe events.</p> <p>Type: String</p> <p>Initial Value: N/A</p> <p>Access: Read/Write</p>
_Recipe_SendByName	<p>Use this system tag to send the specified Recipe to the machine.</p> <p>Type: String</p> <p>Initial Value: N/A</p> <p>Access: Read/Write</p>
_Recipe_SendByNumber	<p>Use this system tag to send the specified Recipe to the machine.</p> <p>Type: Fine Integer</p> <p>Initial Value: N/A</p> <p>Access: Read/Write</p>

_System_Command	<p>Use this system tag to execute the issued command. Set this tag to ResetHIMViewer or 1 to shut down the local HMIVIEWER and restart it. Xpress will restart and display the last loaded panel</p> <p>Type: String</p> <p>Initial Value: 0</p> <p>Access: Read/Write</p>
_System_Memory	<p>Use this system tag to indicate free memory on the machine.</p> <p>Type: UInt</p> <p>Initial Value: 0</p> <p>Access: Read only</p>
_System_Storage	<p>Use this system tag to indicate free storage on the machine.</p> <p>Type: UInt</p> <p>Initial Value: 0</p> <p>Access: Read only</p>
_User_LogOff	<p>Use this system tag to log the local user off of the project while in Runtime. The log on page is displayed.</p> <p>Type: Boolean</p> <p>Initial Value: FALSE</p> <p>Access: Read/Write</p>
_User_LogOn	<p>Use this system tag to initiate the log on popup, allowing the operator to log on to the Runtime machine.</p> <p>Type: Boolean</p> <p>Initial Value: FALSE</p> <p>Access: Read/Write</p>
_User_UserLevel	<p>Use this system tag to display the user level number assigned to the local user.</p> <p>Type: Integer</p> <p>Initial Value: 0</p> <p>Access: Read only</p>

_User_UserLevelName	<p>Use this system tag to display the user level name assigned to the local user. This is the name set on the User Administration page.</p> <p>Type: String</p> <p>Initial Value: N/A</p> <p>Access: Read only</p>
_User_UserName	<p>Use this system tag to display the user name assigned to the local user. This is the name set on the User Administration page.</p> <p>Type: String</p> <p>Initial Value: N/A</p> <p>Access: Read only</p>
_User_UserRegionCode	<p>Use this system tag to display the region code assigned to the logged on user.</p> <p>Type: DINT</p> <p>Initial Value: 0</p> <p>Access: Read only</p>

Using Expressions



When creating tags in Interact Xpress, you can assign expressions to the address. An expression is a combination of functions, operators and other tags. A function is a pre-coded process that generates values for your expression. An operator indicates the action to perform on the number or tag.

For more information on using expressions, refer to the following:

- Accessing Operators and Functions
- General Information on Expressions
- Available Functions and Operators
- Expression Errors

Accessing Operators and Functions

You can access all functions, operators, expressions, and tags from any dialog box where you enter an address. Simply select the appropriate icon on the dialog box to display a drop-down list. The expression icons displayed in Xpress are described below.

Field	Description
Tag List 	Drops down a list of tags currently used in the project. You can select a user-defined tag or a system tag. Tags are listed in alphabetical order, user-defined tags followed by System Tags.
Functions & Operators List 	Drops down a list of available functions and operations for mathematical, logical, and relational expressions.
Recent Expressions List 	Drops down a list of the 10 most recently entered tags, expressions, and control machine addresses. Select an item in the list to reuse it for the tag assignment.

General Information on Expressions

Listed below are the general rules regarding expressions.

- An expression can contain; tags, numbers, operators, and functions.
- Spaces within expressions are ignored.
- The Boolean value True will be evaluated as 1, and False will be evaluated as 0.
- For bitwise manipulations Booleans are treated as if they are single bit values.
- Expressions are case insensitive.
- Trigonometric functions are evaluated using degrees.
- Supported constants in expressions are; TRUE, FALSE, E, and PI

Available Functions and Operators

This section describes the following functions and operators available:

- Functions
- String Functions
- Mathematical Operators
- Relational Operators
- Logical Operators
- Constants
- Order of Precedence

You can access all operators by selecting the Operators and Functions icon located on any screen where you enter an address.

Functions

The equations in the Functions table are based on the following graphic.

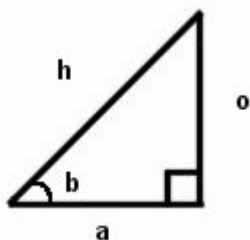

Symbol	Example	Description
SIN(x)	SIN(b)=o/h	Generates the sine of value x.
COS(x)	COS(b)=a/h	Generates the cosine of value x.
TAN(x)	TAN(b)=o/a	Generates the tangent of value x.
ASIN(x)	ASIN(o/h)=b	Generates the arc sine of value x. This is also known as the inverse of sine.
ACOS(x)	ACOS(a/h)=b	Generates the arc cosine of value x. This is also known as the inverse of cosine.
ATAN(x)	ATAN(o/a)=b	Generates the arc tangent of value x. This is also known as the inverse of TAN.
LOG(x)	LOG(tag)	Generates the natural base logarithm of the value x.
LOG10(x)	LOG10(tag)	Generates the base-10 logarithm of the value x.
EXP(x)	EXP(tag); EXP(2)	Generates the natural exponential of irrational number e (approximately 2.718281) by raising it to the power of x.
ABS(x)	ABS(tag); ABS(-2)	Generates the absolute value of x.
SQRT(x)	SQRT(tag); SQRT(2)	Generates the square root of value x.
POW(x, y)	POW(tag1, tag2); POW(tag1, 2)	Raises value x to the power of value y.
RAD(x)	RAD(tag); RAD(2)	Converts degrees (value x) to radians.
DEG(x)	DEG(tag); DEG(2)	Converts radians (value x) to degrees.

String Functions

Symbol	Example	Description
LEFTSTRING(string,NumberOfCharacters)	LEFTSTRING(strString,4)	Returns "Park".
MIDSTRING(string,StartPosition,NumberOfCharacters)	MIDSTRING(strString,2,5)	Returns "arker".

RIGHTSTRING(string,NumberOfCharacters)	RIGHTSTRING(strString,3)	Returns "ion" .
STRLEN(string)	STRLEN(strString)	Returns 17.
TRIMLEFT(string)	TRIMLEFT(strTrim)	Returns "Xpress ". No spaces to the left of the string but keeps the spaces to the right.
TRIMRIGHT(string)	TRIMRIGHT(strTrim)	Returns " Xpress". No spaces to the right of the string but keeps the spaces to the left.

In the above examples, assume strString = "Parker Automation". Also assume strTrim = " Xpress ", (there are 3 spaces on either side of the string tag strTrim).

Mathematical Operators

Symbol	Example	Description
+	tag1 + tag2	Addition - sums the left and right values.
-	tag1 - 45	Subtraction - subtracts the right value from the left value.
*	tag1 * 2.45	Multiplication - multiplies the left and right values.
/	tag1 / 100	Division - divides the left value by the right value.
%	tag1 % 3	Modulus - returns the remainder of the division of the left value by the right value.
<<	tag1 << 4	Bit shift left - shifts the bits of the binary value to the left, by the number of times specified by the right value.
>>	tag1 >> tag2	Bit shift right - shifts the bits of the binary value to the right, by the number of times specified by the right value.

Relational Operators

Symbol	Example	Description
<	tag1 < 50.5	Less Than — TRUE if the left value is less than the right value.
<=	tag1 <= tag2	Less Than or Equal To — TRUE if the left value is less than or equal to the right value.
>	tag1 > tag2	Greater Than — TRUE if the left value is greater than the right
>=	tag1 >= 50.5	Greater Than or Equal To — TRUE if the left value is greater than or equal to the right value.
==	tag1 == tag2	Equality — TRUE if the left value is equal to the right value.
!=	tag1 != 0	Does Not Equal — TRUE if the left value does not equal the right value.

Logical Operators

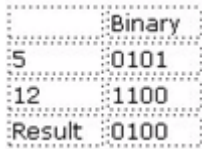
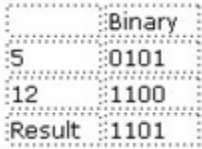
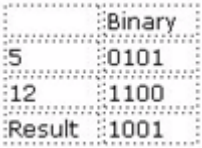
Symbol	Example	Description
&&	(Tag1 > 2) && (Tag1 < 3)	Logical And — Compares two values or expressions. The result is one only if both values are non-zero.
	0 Tag1	Logical Or — Compares two values or expressions. The result is one if one of the two values is non-zero.
!	!(Tag1 < 5)	Logical Not — Changes a non-zero value to a zero, and changes a zero value to a non-zero.
&	Tag1 & 12 Result: If Tag1 = 5 	Bitwise And – Compares two operands bit by bit. The resulting bit is one only if both bits in the operand are one.
	Tag1 12 Result: If Tag1 = 5 	Bitwise Or – Compares the two operands bit by bit. The resulting bit is one if one of the two bits in the operands is one.
^	Tag1 ^ 12 Result: If Tag1 = 5 	Bitwise Exclusive Or – Compares two operands bit by bit. The resulting bit is one if one of the two bits (but not both) in the operands is one.
~	~Tag1 Result: If Tag1 = 5 5 in binary: 0101 therefore the result is 1010	Bitwise Not – Changes each one to a zero and each zero to a one.

Constants

Symbol	Example	Description
_CONST_E	E + 2 Result: 4.718281.	<p>Natural exponential function — The value of E is approximately 2.718281.</p> <p>Returns the constant value of E. E is the natural logarithmic base used in mathematical equations to compute, among other things, compound interest and statistical bell curves.</p> <p>Use this tag in the Address field of the Tag Editor as part any mathematical equations you need.</p> <p>Type: LREAL</p> <p>Initial Value: 2.718281828</p> <p>Access: Read only</p>
_CONST_PI	Pi + 3 Result: 6.141592.	<p>Pi— The ratio of the circumference to the diameter of a circle. Approximately 3.141592.</p> <p>Returns the constant value of pi. Pi is the ratio of the circumference of a circle to its diameter.</p> <p>Use this tag in the Address field of the Tag Editor as part any mathematical equations you need.</p> <p>Type: LREAL</p> <p>Initial Value: 3.141592654</p> <p>Access: Read only</p>
FALSE	FALSE Result: Address reference is set to FALSE or zero.	<p>Returns a constant value of FALSE. In Boolean, False = 0.</p> <p>Type: Boolean</p> <p>Initial Value: FALSE</p> <p>Access: Read only</p>
TRUE	TRUE Result: Address reference is set to TRUE or one.	<p>Returns a constant value of TRUE. In Boolean, True = 1.</p> <p>Type: Boolean</p> <p>Initial Value: TRUE</p> <p>Access: Read only</p>

Order of Precedence

The precedence of operators determines the order in which operators are evaluated in an expression. Anything in parenthesis () is evaluated first. For example,

$$2 * 3 + 4 = 10$$

but with added parenthesis, the expression is evaluated differently:

$$2 * (3 + 4) = 14$$

The following table lists the order of precedence, with the topmost operator evaluated first:

Operator Order of Precedence (OOP)					
OOP	Symbol	OOP	Symbol	OOP	Symbol
1.	()	8.	<<	15.	&
2.	*	9.	<	16.	~
3.	/	10.	>	17.	
4.	%	11.	<=	18.	^
5.	+	12.	>=	19.	&&
6.	-	13.	==	20.	!
7.	>>	14.	!=	21.	

Expression Errors

If there is an error in your expression, an error message is displayed on the address flyout, indicating what the error is, and the cursor is placed within the entry field at the point where Interact Xpress encountered the problem.

Errors will be shown for:

- Incorrect expression syntax such as: An equal sign as the first operator in the expression. For example: '= 10 + Tag1'
- Unsupported operators or functions.
- Consecutive use of two operators without the use of parentheses.
- Excluding the value in the function: 'SIN()'

Within the Tag Editor errors will be shown for circular references, write scaling, and scaling of direct addresses. Examples are shown in the tables below.

Circular references in scaling expressions

Status	Name	Address
!	Tag1	Tag2
!	Tag2	Tag3
!	Tag3	Tag1

Write Scaling

Status	Name	Address
!	Tag1	= 2 * Tag2
!	Tag3	Tag4 = 2 * Tag5

Scaling a direct address

Status	Name	Address
!	Tag1	2 * channel1.device1.m1

Using Data Types

A data type determines the type value of the tag. Interact Xpress supports IEEE single precision floating point and double precision floating point numbers.

Some additional rules used with data types are listed below.

- All Strings are NULL terminated.
- The Default data type is determined by the device driver selected for this project.
- The data type field is validated when you select the OK button or by clicking off of the Edit Tag dialog.
- Tag arrays, as well as Bytes, Words, and DWords are not supported.

The table below describes each available data type and lists its size and range of value.

Data Type	Description	Size	Range
Default	Default type defined by the device.	varies	varies
BOOL	Bit string of 1 bit	1 bit	0 or 1, TRUE or FALSE
SINT	Short Integer	8 bits	-128 to 127
USINT	Unsigned Short Integer	8 bits	0 to 255
INT	Integer	16 bits	-2^{15} to $(+2^{15} - 1)$
UINT	Unsigned Integer	16 bits	0 to $(+2^{16} - 1)$
DINT	Double Integer	32 bits	-2^{31} to $(+2^{31} - 1)$
UDINT	Unsigned Integer	32 bits	0 to $(+2^{32} - 1)$
REAL	Real	32 bits	-10^{-38} to $+10^{+38}$
LREAL	Long Real	64 bits	-10^{-308} to $+10^{+308}$
STRING	Character Strings	2048 char max	not applicable

Tag Scaling

Tag scaling is the adjustment of a value using functions or expressions. There are two types of scaling, input (or write) scaling and output (or read) scaling.

General Information on Scaling

As you are working with the tools, you can create new tags from any input tool menu. Those tags are then automatically added to the Tag Editor and accessible to the rest of your project. All tags that you create from within the tools appear on the Tags drop-down list in the Edit Tag screen.

Note that you cannot directly reference a device address in your expressions. Instead, you must create a tag in the Tag Editor and assign it to the device address. Then you can reference that tag in the tool.

Input/Write Scaling

Write scaling is performed on the data value of a tag tied to an input tool. When you scale a tag value in an input tool, use a question mark (?) as the identifier for the input.

Input scaling takes the form of mathematical equations. For example:

$$\text{Tag1} = \text{Tag2} + ?$$

- The question mark (?) is the identifier for the input to the tool. This represents where the tool writes the value.

- Question marks are valid for input tools only.
- You can have multiple question marks in an expression.
- Values are updated only when the input changes, not when any tags in the expression change. This differs from the Tag Editor, where a write is performed when tags in the expression change.
- Expressions must be read/write. In other words, you must use a question mark whenever you use an expression (that is, perform input scaling) in an input tool.
- You can still specify a tag only (that is, without an expression and without scaling) in an input tool.

Output/Read Scaling

Read scaling is performed on the data value of a tag tied to an output tool. Output scaling does not require the question mark, since there is no input identifier necessary for output tools.

Output scaling does not use equal signs, either. An output scaling example may look like the following:

Tag1 + Tag2

- You can use constants in your output tool expressions.
- You cannot use question marks with output tools.
- Equals signs (=) are not valid in output tools.

Additional Scaling Information

- You can use expressions to scale tags, both input scaling and output scaling, directly within the tag fields of input tools configuration menu.
- With input scaling, you must use the following format: MyTag = expression. With output scaling, you simply use the expression.
- You cannot directly address Xpress COMMServer addresses at the tool level. For example, 2 * channel1.device1.m1 is not allowed. You can create a tag with the address channel1.device1.m1, and then scale using that tag name such as 2 * <tagname>.
- Equals signs (=) in an input scaling expression tell the application where to write. When you use an equals sign, you must specify a value to the left of it.
- There are two things you cannot specify on the left of an equals sign: question marks and constants.
- You can create new tags in the tools. They will be automatically added to the Tag Editor. However you can only use existing tags on the left of an equals sign in an expression.
- You can click the tag field then select the function or operator using the same icons that are available in the Edit Tag dialog. Selecting these icons lists the expressions, operators, functions, and all user and system tags available in your application.
- If there is an error in your expression, it will appear in red in the Tag Editor.

Examples

- Some valid scaling examples for write scaling (input tools) are
 - tag1 = ? + CONST_PI
 - tag1 = tag2 + ?
 - tag1 = sin(?)

- The expression `tag1 = ?` tells the application to take the input of the tool and write it to `tag1`.
- Specifying `tag1` in an input tool is the same as specifying the expression `tag1 = ?`.
- The expression `= ?` is not valid. You must specify a value to the left of the equals sign so that the application knows where to perform the write.
- In the expression `tag1 = ?`, `tag1` cannot be a constant.
- Some valid scaling examples for read scaling (output tools) are:
 - `2 * Tag1`
 - `(Tag2 > 5) * 500 + Tag3`
 - `Sin(Tag4)`
 - `Tag2 && Tag3`
- For example, a Numeric Display tool has a Display Output assignment of `'2 * Tag1'`. `Tag1` exists in the Tag Editor as a tag with the address assignment `'channel1.device1.m1'`. When the value of the memory address `m1` changes on the device, then the scaling expression is evaluated and the result of `'2 * Tag1'` will be displayed on the Numeric Display tool.
- A second example is if a Numeric Display tool has a Display Output assignment of `'Tag2'`. `Tag2` exists in the Tag Editor as a tag with the address assignment `'2 * Tag1'`. `Tag1` exists in the Tag Editor with the address assignment `'channel1.device1.m1'`. When the value of the memory address `m1` changes on the device, then the scaling expression is evaluated and the result of `'2 * Tag1'` will be sent to `Tag2`. `Tag2`'s value will be displayed on the Numeric Display tool.

Tag Rules

The following topic outlines the rules for addressing local tags and tags tied to a controller address.

Local Tags

A local tag reference virtual memory locations on your Runtime workstation. This type of tag is not connected to a controller and is not retentive.

Rule 1

To assign a tag, constant, or expression to another tag, simply enter the tag, constant, or expression in the Address field.

Name	Address	Type	Initial Value	Result
Tag1	Tag2	Default		The value of Tag2 is assigned to Tag1. When Tag2 changes, Tag1 changes to match. Whenever Tag1 changes, Tag2 changes to match as well.

Rule 2

To assign a tag, constant, or expression to another tag without having a reciprocal relationship between them, use the equals sign (=).

Name	Address	Type	Initial Value	Result
Tag1	=Tag2	Default		The value of Tag2 is assigned to Tag1. When Tag2 changes, Tag1 changes to match. However, when Tag1 changes, Tag2 does not change to match.

Important: Values on the right of an equals sign are assigned to what is on the left of the equals sign. However values written to the left of the equals sign will not be assigned to what is on the right of the equals sign.

Rule 3

To set the Access to Read Only, do not use the equals sign in an expression in the Address field.

Name	Address	Type	Initial Value	Result
Tag1	Tag2+Tag3	Default		Keep Rule 2 in mind. When Tag2 and Tag3 change, their sum is assigned to Tag1. However, if Tag1 changed, then Tag2 and Tag3 would also have to change. We cannot determine how Tag2 and Tag3 should change to accommodate a new value in Tag1. Therefore, the Access of Tag1 is automatically set to Read Only. In this case you would receive a write error symbol over the tool that is

Rule 4

To set the Access to Read/Write, use the equals sign in an expression in the Address field.

Name	Address	Type	Initial Value	Result
------	---------	------	---------------	--------

Tag1	=Tag2+Tag3	Default		Keep Rule 2 in mind. When Tag2 and Tag3 change, their sum is assigned to Tag1. And because the expression falls to the right of the equals sign, Tag1 can change without having to reciprocate that change in Tag2 and Tag3. Therefore, the Access of Tag1 is automatically set to Read/Write. There will be no change in Tag2 or Tag3.
Tag1	Tag2=Tag3	Default		If Tag3 changes, both Tag1 and Tag2 will change to match. If Tag2 changes, Tag1 changes to match, but Tag3 does not change because Tag3 appears to the right of the equals sign. And if Tag1 changes, Tag2 changes to match, but Tag 3 does not change. The Access of Tag1 remains Read/Write.

Rule 5

You cannot assign a tag to itself.

Name	Address	Type	Initial Value	Result
Tag1	Tag1	Default		Causes a Circular Reference error.
Tag1	=Tag1	Default		Causes a Circular Reference error.

Xpress COMMServer Tags

The hardware addresses in the examples below use the syntax ch1.d1.k1 , where ch1 represents the Channel, d1 represents the Device, and k1 represents the memory address.

Rule 1

When directly addressing a controller you must assign a hardware address to the tag.

Name	Address	Type	Initial Value	Result
Tag1	ch1.d1.k1	Default		The value of ch1.d1.k1 is assigned to Tag1. When ch1.d1.k1 changes, Tag1 changes to match. Whenever Tag1 changes, ch1.d1.k1 changes to match as well.

Rule 2

You can assign tags to hardware addresses in the Address field. The equals sign functions the same regardless if a local or COMMServer tag.

Name	Address	Type	Initial Value	Result
Tag1	'ch1.d1.k1'=Tag2	Default		<p>If the value at Tag2 changes, the new value is assigned to both ch1.d1.k1 and Tag1.</p> <p>If ch1.d1.k1 changes, Tag1 changes to match, but Tag2 does not change. If Tag1 changes, ch1.d1.k1 changes to match, but Tag2 does not change.</p>

Rule 3

You can only assign hardware addresses to other hardware addresses. Furthermore, if you are using a hardware address to the right of an equals sign, you must place the hardware address in single quotes.

Name	Address	Type	Initial Value	Result
Tag1	'ch1.d1.k0'='ch1.d1.k1'+Tag2	Default		<p>If the value at ch1.d1.k1 changes, the new value is added to Tag3 and then assigned to both ch1.d1.k0 and Tag1.</p> <p>If Tag1 changes, ch1.d1.k0 changes to match, but ch1.d1.k1 and Tag3 do not change.</p> <p>If ch1.d1.k0 changes, only Tag1 changes to match.</p>

CHAPTER 9:
Using the Alarm Editor



Using the Alarm Editor

The Alarm Editor is a powerful feature of Interact Xpress. It allows you to monitor various events on the Runtime machine. When you run your project, Interact Xpress continuously monitors the tags for out-of-tolerance (alarm) conditions. When the alarm condition you define goes TRUE, the alarm triggers. When the alarm is triggered, you can:

- alert the operator
- provide information on the alarm condition
- allow the operator to acknowledge the alarm
- instruct the operator to take corrective action

In the Alarm editor, you can set different priority levels for each alarm or choose to group alarms together by priority. You can setup how the alarm is cleared, if it is audible or not, and how long the alarm is active. You can also log the alarm events to a file.

For more information on setting up alarms and using the Alarm editor, refer to the following:

- The Alarm Editor Display
- The Alarm Editor Menu
- Creating Alarms
- The Alarm Viewer Tool

The Alarm Editor Display

The Alarm editor displays the defined alarms and their triggers. You can define a total of 999 alarm conditions. The Alarm editor is shown below.



Notice that the Alarm editor contains a status line located at the bottom of the screen. The status area displays the number of alarms currently defined, as well as the values for the highlighted alarm.

The Alarm Editor Menu

The following table briefly describes the menu options available in the Alarm editor.

Menu Item	Description
General Setup	Under the General Setup menu you can define the following: <ul style="list-style-type: none">■ how alarms are cleared■ if an alarm is audible■ how long an alarm is active■ the displayed time format
Groups	Allows you to organize the alarms into logical groups. The Group menu is displayed with a listing of groups replacing the Alarm editor view. When a group in the grid is highlighted, the properties in the Group menu contain values that belong to the selected group.
Priorities	Allows you to change how a certain alarm priority is displayed in the alarm viewer. For example, you can define the color of a displayed alarm with an urgent priority, or have an alarm with a warning priority sound an audible tone. The Priority menu is displayed with a listing of priorities replacing the Alarm editor view.
File Logging	Allows you to define what alarms you want to log. The File Logging menu is displayed.
New Alarm	Allows you to add an alarm. The Edit Alarm screen is displayed which allows you to define the alarm condition. For more information on defining alarms, refer to Creating Alarms.
Edit Alarm	Allows you to edit an alarm. The Edit Alarm screen is displayed which allows you to change the alarm values. For more information on defining alarms, refer to Creating Alarms.
Delete	Deletes the selected alarm.

Setting Up Alarm Properties

Using the **General Setup**, you can define how an alarm is cleared, if it is audible or not, how long the alarm is active, as well as the time format.

Select General Setup from the Alarms menu. The General Setup menu is displayed.

The following table describes the alarm properties available from the General Setup menu.

The General Setup Menu	
Property	Description
Clear Alarms	<p>Automatic: Select this option to automatically clear alarms. Alarms must be inactive before they will clear.</p> <p>Acknowledgment Required: Select this option to clear alarms only after they are inactive and have been acknowledged.</p>
Annunciation Duration	<p>Until Alarm Inactive: Select this option to allow the alarms to continue flashing and/or beeping until the alarm goes inactive.</p> <p>Until Alarm Acknowledged: Select this option to allow the alarms to continue flashing and/or beeping until the alarm has been acknowledged .</p>
Time Format	<p>Selects how the time appears on an alarm display.</p> <p>24 Hour: Select this option to display the time in 24 hour format (01:00:00 - 23:59:00). For example, 6:00PM equals 18:00. This is the default option.</p> <p>12 Hour: Select this option to display the time in 12 hour format (01:00:00 - 12:59:00 A or P).</p>

Creating Alarm Groups

You can organize alarms together to create logical groups. Groups let you separate alarms into sets that share something in common such as:

- All alarms on the same machine
- All alarms of a given priority
- All alarms related to the same process or function

A typical use is to assign the alarms from each machine into separate groups. During Runtime, the operator can enable or inhibit an entire group of alarms at once. For example, this allows you to disable all of the alarms pertaining to a machine when that machine is taken off-line for maintenance.

Note: Alarms not assigned to a group are automatically assigned to the default group Global . A group can contain alarms of different priorities.

To setup an alarm group, select **Groups** from the Alarms menu. The Group menu and list is displayed as shown below.

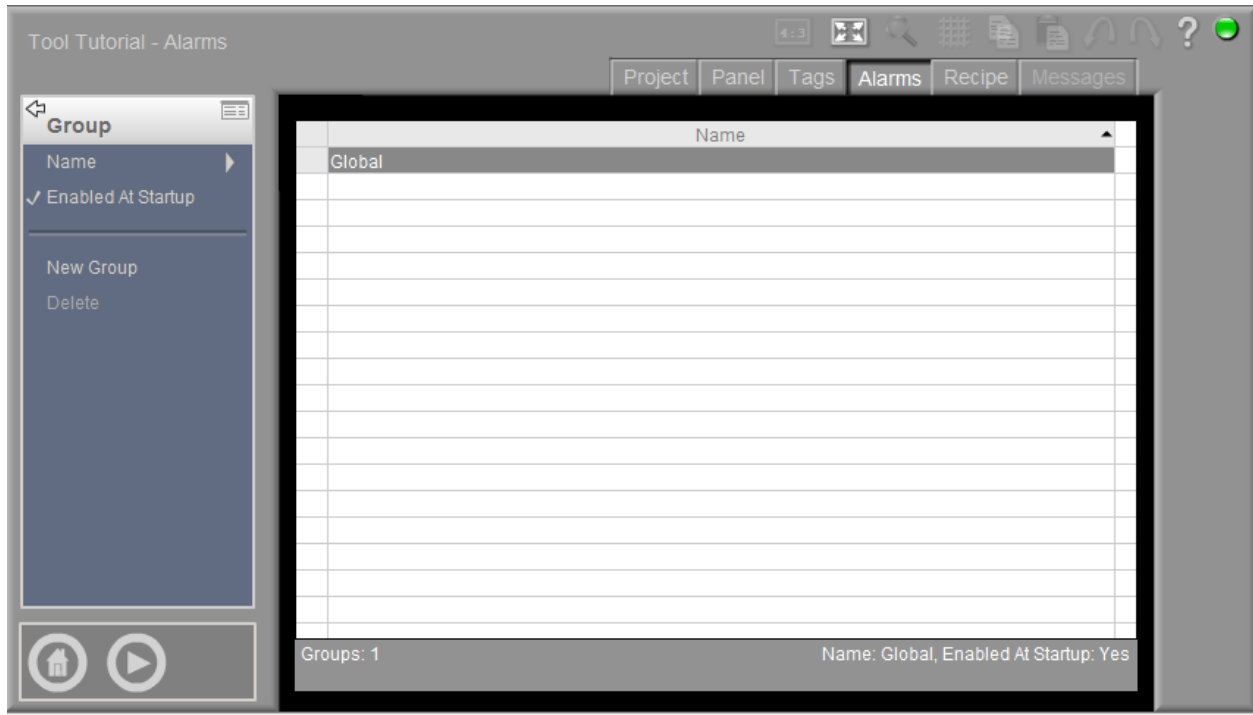

The following table describes the properties available from the Group menu.

Property	Description
Name	<p>Enter or edit the group name. There are a few restrictions as to what can appear in the Name field:</p> <ul style="list-style-type: none"> ■ Names can have up to 32 characters. ■ The first character must be a letter. ■ Names must contain only alphanumeric characters and underscores (_). ■ The field cannot be empty.
Enable at Startup	<p>When checked, the alarm group is enabled when you run the application.</p> <p>If this option is checked, each time you run the application, alarms assigned to the selected group are either enabled or inhibited depending on each individual alarm's Enabled at Startup property.</p> <p>If this option is not checked, each time you run the application, alarms assigned to the selected group are inhibited regardless of the setting of the individual alarm's Enabled at Startup property.</p> <p>This option is checked by default.</p>
New Group	<p>Allows you to add an alarm group. A new group is added with a default name of Group001. To change the name, highlight the new group and select the Name property.</p>

Delete	Deletes the selected alarm group. You can use the Undo command to recover the last deleted group.
--------	---

Setting Alarm Priorities

You can assign one of five different priority levels for an alarm. Priority 1 is the lowest priority and 5 is the highest. You can assign names to the priority levels to provide the operator with useful information. The priority name is optional and can be up to 32 characters long. The default names are shown below.

Priority Number	Priority Name
1	Notice (Lowest)
2	Warning
3	Alert
4	Urgent
5	Critical (Highest)

The priority number is used when you run the application to display and acknowledge alarms. For example, you can force an operator to acknowledge all priority 5 alarms individually instead of all at once.

To set a priority for an alarm, select the **Priorities** property from the Alarms menu. The Priority menu and list are displayed as shown below:

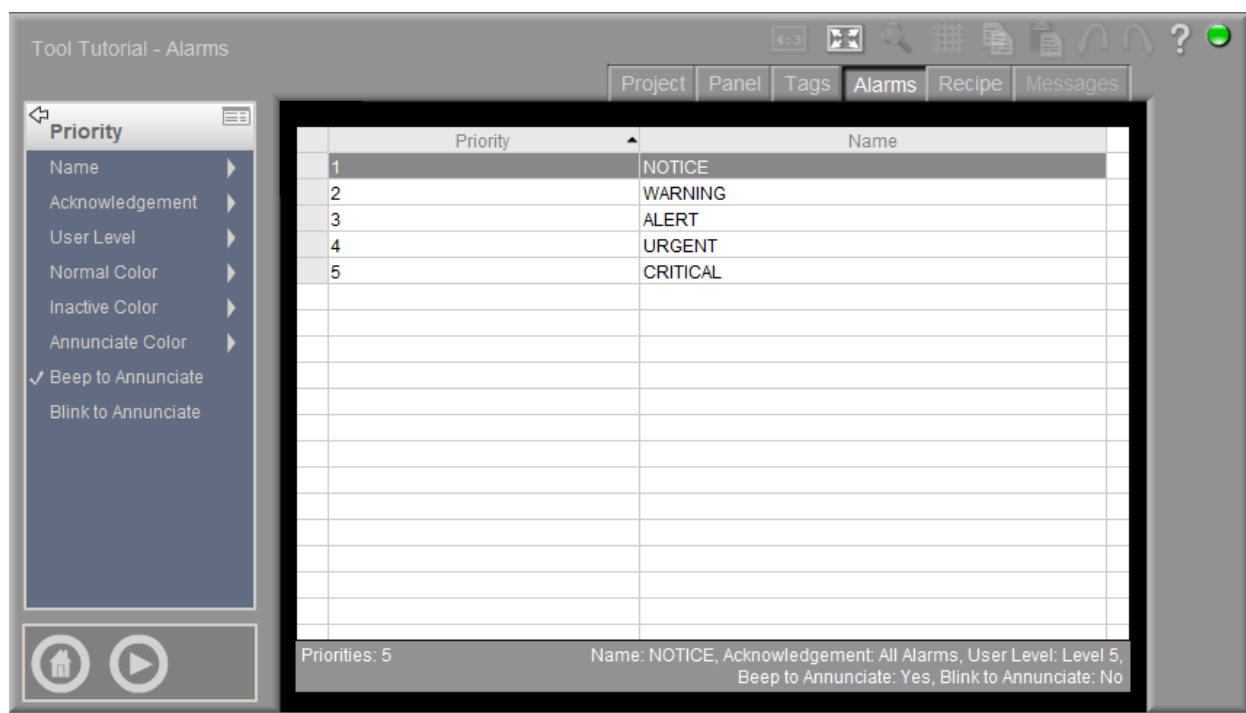

Highlight a row in the Priority list and the menu changes to reflect the current settings for that priority level. The following table describes the properties available from the Priority menu.

Property	Description
Name	<p>Enter or edit the priority name. There are a few restrictions as to what can appear in the Name field:</p> <ul style="list-style-type: none"> ■ Names can have up to 32 characters. ■ The first character must be a letter. ■ Names must contain only alphanumeric characters and underscores (_). ■ the field cannot be empty.
Acknowledgement	<p>You can allow the operator to acknowledge all alarms at once or choose to have the operator acknowledge each alarm individually.</p> <p>All Alarms: Select this option to acknowledge all alarms of the selected priority with a single press of the Acknowledge button.</p> <p>Individual Alarms: If you select this option, you must select each alarm in the Alarm Summary viewer before you press the Acknowledge button.</p> <p>You may want to configure individual Acknowledgment for critical alarms. This forces the operator to examine each alarm before acknowledging it. For example, set:</p> <ul style="list-style-type: none"> ■ Priorities 1 through 4 for All Alarms. ■ Priority 5 for Individual Alarm. <p>Note: To setup an Acknowledge button for individual alarms, use the AckSelectedAlarm connection point. For more information on using connections, see <i>Creating Connections to the Alarm Viewer Tool</i> on page 10-14.</p>
User Level	<p>You can assign an acknowledgment User Level to each priority. Use this feature to prevent unauthorized personnel from acknowledging high priority alarms.</p>
Normal Color	<p>Select the color the alarm has in its normal or active state when displayed in the Alarm viewer.</p>
Inactive Color	<p>Select the color the alarm has in its inactive state.</p>
Annunciate Color	<p>Select the color the alarm has if the alarm is triggered.</p>
Beep to Annunciate	<p>You can opt to have an alarm beep to alert the operator. A checkmark is displayed showing that this is turned on. Select it again to turn it off.</p>
Blink to Annunciate	<p>You can opt to have an alarm blink in the Alarm viewer. A checkmark is displayed showing that this option is turned on. Select it again to turn it off.</p>

Logging Alarm Events

You can setup a log file to capture all alarm events triggered during a certain time period.

To setup a log file, select **File Logging** from the Alarms menu. The File Logging menu is displayed. The following table describes the menu items on the File Logging menu.

The File Logging Menu	
Property	Description
Max. Number of Events	Enter the maximum number of events you want to capture in the log file.
File Backup Path	<p>Enter the path where you want the backup log file to reside. The default filename for the backup log is <i>alarm_backup.txt</i>.</p> <p>If a username and password is needed to access the path where you want the file to reside, enter it here. For example, if you want to backup the log file to a network drive and a username and password is needed to access that drive, you must enter the correct username and password.</p> <p>Pressing the Test Path button allows Xpress to login and verify the path where you want the backup file written.</p>
Groups to Log	Select the groups you want to log.
Priorities to Log	Choose the alarm conditions you want to log based on priority level. You can select any or all priority levels. For example, you may want to log only the urgent and critical alarms. To do so, uncheck the other priority levels.

Creating Alarms

Alarms allow you to monitor various events on the Runtime machine. When you run your project, Xpress continuously monitors the tags for out-of-tolerance (alarm) conditions. When the alarm condition that you specify goes TRUE, the alarm triggers. You can define a total of 999 alarm conditions.

Use the Alarm editor to setup alarms for your project. You can also import and export alarm definition files, for more information, see Importing and Exporting Tags and Alarm Definitions.

To create alarms in your project:

1. From the Project editor, select the **Alarms** tab. The Alarm editor is displayed.
2. To add or edit an alarm:

If you want to...	Then...
Add a new alarm	Select New Alarm from the Alarm editor menu. The Edit Alarm screen is displayed as shown below.

Edit an existing alarm

Highlight an alarm and select **Edit Alarm** from the Alarm editor menu or you can highlight the alarm and double-click on it. The Edit Alarm screen is displayed as shown below.

The following table describes the properties on the Edit Alarm screen.

Property	Description
Description	Enter the name of the alarm condition. You can use up to 256 characters. The default name is Alarm001. If Alarm001 already exists, the new name is Alarm002, and so on.

Alarm Trigger	<p>Enter a tag or an expression that when its condition is TRUE in Runtime, the alarm is active (or triggered). For example:</p> <table border="1"> <thead> <tr> <th>Tag or Expression</th> <th>Value</th> <th>Evaluated as...</th> </tr> </thead> <tbody> <tr> <td>Tag1</td> <td>0</td> <td>FALSE</td> </tr> <tr> <td>Tag1 = 17</td> <td>17</td> <td>TRUE; anything else is evaluated as FALSE</td> </tr> <tr> <td>Tag1 > 17</td> <td>20</td> <td>TRUE; anything less than 17 is evaluated as FALSE</td> </tr> <tr> <td>Tag1 + (10/Tag2)</td> <td>0</td> <td>FALSE; anything else is evaluated to TRUE</td> </tr> </tbody> </table>	Tag or Expression	Value	Evaluated as...	Tag1	0	FALSE	Tag1 = 17	17	TRUE; anything else is evaluated as FALSE	Tag1 > 17	20	TRUE; anything less than 17 is evaluated as FALSE	Tag1 + (10/Tag2)	0	FALSE; anything else is evaluated to TRUE
Tag or Expression	Value	Evaluated as...														
Tag1	0	FALSE														
Tag1 = 17	17	TRUE; anything else is evaluated as FALSE														
Tag1 > 17	20	TRUE; anything less than 17 is evaluated as FALSE														
Tag1 + (10/Tag2)	0	FALSE; anything else is evaluated to TRUE														
Priority	Select a priority level for this alarm condition. You can choose between five different priority levels: Notice, Warning, Alert, Urgent, and Critical.															
Group	Select an alarm group. You can organize alarms into different groups, such as all notice level alarms. Before you can select a group, you must first define it. Refer to Using the Alarm Editor for more information on defining an alarm group. The default group is Global.															
Alarm Value	<p>Select either Reference or Text. If Reference is enabled, a tag or expression can be entered during Runtime.</p> <p>If Text is enabled, you can instruct the operator to take corrective action. Enter a text message, up to 256 characters, in the blank field below the Alarm Value field. Whenever an alarm is triggered in Runtime, the text message is displayed in the Alarm Viewer.</p>															
Email When Active	When checked, an email will be sent when the alarm is activated.															
Enable at Start Up	When checked, the alarm is enabled when the project connects. If the alarm is initially disabled, you can enable it during Runtime.															
Use Default Email Address	When checked, the alarm email will be sent to the default address. The default address is set up in the Setting Menu in Shell. See the Configuring Email section of this user guide for more information.															
Email Address	Enter the email address specifically for this alarm. This will only be used if the Use Default Email address is checked. To send emails to multiple addresses, separate each email address with a comma.															

Interact Xpress checks for illegal tag names, improper data, etc. If an error is found, that field is skipped. As each field is checked, the status field is left blank in the Alarm editor for any fields found in error.

The Alarm Viewer Tool

Use the Alarm Viewer to display information on alarm conditions. You can view current alarm information as well as alarm history. You can also enable or disable alarms based on the alarm type you specify.

The following table describes the properties available from the Alarm Viewer menu.

Property	Description
Name	<p>Enter a unique name for the Alarm Viewer, up to 32 characters. Multiple Alarm Viewers can also share the same name. Names must start with a letter.</p> <p>The default name is AlarmViewer001, and increments by one with each new viewer added.</p>
Type	<p>Select the type of alarm data you want to view.</p> <p>Alarm Summary lets you view current alarm information in a variety of formats. You can acknowledge alarms, clear alarms, supply comments, and view detailed information on each alarm.</p> <p>Alarm History provides you with logged history information including what time the alarm was triggered, the date the alarm was triggered, and so on.</p> <p>Alarm Control lets you enable or inhibit alarms either individually or as a group.</p>

Fields

Select the different fields you want to display in the Alarm Viewer. The fields available are based on the type of alarm data you want to display. The following is a list of fields available for each alarm group:

Fields Available

- Time On – Summary display
- Time Ack – Summary display
- Description – All display types
- Time On – Summary display
- Priority – Summary and History display
- Alarm Value – Summary and History display
- Current Value – Summary display
- Group – All display groups
- Time Off – Summary display
- Date On – Summary display
- Date Off – Summary display
- Date Ack – Summary display
- User – Summary and History display
- Status – History display
- Time – History display
- Date – History display
- Enabled – Control display

By Default, all fields are displayed in the Alarm Viewer. Any checked item is displayed in its own column in the Alarm Viewer. Any field that is not checked is not displayed in the viewer.

You can change the order of the displayed fields by highlighting them and using up and down buttons at the bottom of the Fields pop up box.

You can adjust the width of each field by using the sizing points displayed when the Alarm Viewer tool is selected as shown below.

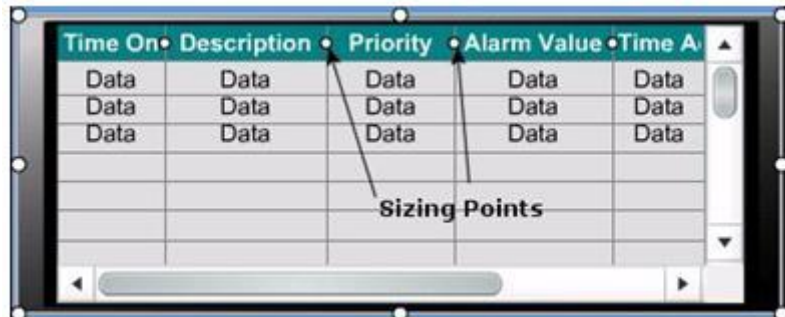

Appearance	The appearance properties let you change the look of the Alarm Viewer. You can change the style, display area, header and grid color. For details on appearance properties, see Changing Tool Appearance.
Accessibility	The accessibility properties determine whether or not a tool is visible to all users during Runtime. For more information, refer to Changing Tool Accessibility.

Creating Connections to Alarm Viewer Tool

Once you have created your alarm conditions, an Alarm Viewer Tool, and buttons on your panel, you need to create connections to your Alarm Viewer. Connections allow the Alarm Viewer Tool to talk to other tools on the panel. By adding buttons, indicators, and display tools on your panel, you can acknowledge, enable and disable, clear, and sort your alarms.

The following connections are available for use with an Alarm Viewer tool. However, not all of the connections are available with each tool. Some connections are for use only with specific tools such as the Alarm Summary Viewer vs. an Alarm Control Viewer.

Connections Used with an Alarm Viewer Tool	
Connection	Description
AckSelectedAlarm	Use this connection with a Button tool to allow the operator to acknowledge the highlighted alarm. This connection is only available with the Alarm Summary Viewer.
ClearSelectedAlarm	Use this connection with a Button tool to allow the operator to clear the highlighted alarm. This connection is only available with the Alarm Summary Viewer.
SortByDateTime	Use this connection with a Button tool to allow the operator to sort all alarm conditions by the date and time they occurred. This connection is only available with the Alarm Summary Viewer.
SortByPriority	Use this connection with a Button tool to allow the operator to sort all alarm conditions by their priority levels, most severe to least severe. This connection is only available with the Alarm Summary Viewer.
DisableSelectedAlarm	Use this connection with a Button tool to allow the operator to disable the highlighted alarm. This connection is only available with the Alarm Control Viewer.
DisableSelectedGroup	Use this connection with a Button tool to allow the operator to disable the highlighted alarm group. This connection is only available with the Alarm Control Viewer.
EnableSelectedAlarm	Use this connection with a Button tool to allow the operator to enable the highlighted alarm. This connection is only available with the Alarm Control Viewer.
EnableSelectedGroup	Use this connection with a Button tool to allow the operator to enable the highlighted alarm group. This connection is only available with the Alarm Control Viewer.

CHAPTER 10: Using the Recipe Editor



Using the Recipe Editor

You can use the Recipe editor to populate your recipe with data items that correspond to a particular value sent to the control machine. Recipes are a list of items that use analog, discrete, or string values to send all at once to the Xpress machine, rather than sending each value one at a time.

You can setup a simple Button to send a recipe to the Xpress machine, or you can use a Recipe Viewer tool to display Recipes to the operator and allow the operator to change values as needed. During Runtime, all of the Recipes you define in your project are displayed in a Selection List popup tool.

For more information on using Recipes and the Recipe editor, refer to the following sections:

- The Recipe Editor Display
- The Recipe Menu
- The Recipe Viewer Tool
- Adding and Editing a Recipe Item
- The Recipe Viewer Tool

The Recipe Editor Display

The Recipe editor displays the selected recipe and all of the items currently in the list, as shown below.

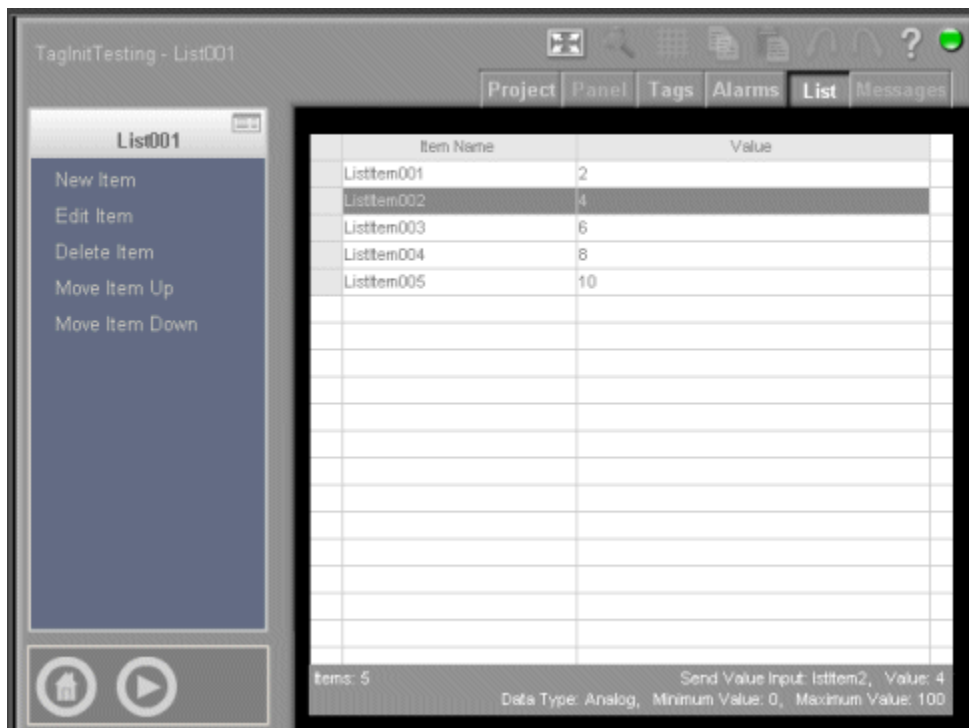

Each recipe item has a data value that is associated with it which corresponds to the type of data sent to the control machine. You can have one of three data types:

- **Analog:** Sends an analog value to the Xpress machine.
- **Discrete:** Sends a discrete value to the Xpress machine.
- **String:** Sends a string value to the Xpress machine.

Notice that the Recipe Editor contains a status line located at the bottom of the screen. The status area consists of two lines of information. The first line displays the Send Value Input tag and its corresponding value. The second line displays information according to the data type as shown in the table below.

Data Type	Information Displayed
Analog	Displays the minimum value, the maximum value, and the Send Value Input tag.
Discrete	Displays whether Label 0 and 1 are set to on or off as well as the Send Value Input tag.
String	Displays the Send Value Input tag.

The Recipe Menu

The following table describes the menu options available in the Recipe editor.

Menu Item	Description
New Item	Allows you to add a data item to your input list. The Edit Input List Item screen is displayed which allows you to set the data type, the Send Value Input tag, and corresponding values. For more information on setting these values, refer to Adding and Editing a List Item .
Edit Item	Allows you to edit a data item to your input list. The Edit Input List Item screen is displayed which allows you to change the data type, the Send Value Input tag, and corresponding values. For more information on setting these values, refer to Adding and Editing a List Item .
Delete Item	Deletes the selected data item from the input list.
Move Item Up Move Item Down	Select one of these options to move the data item up or down in the displayed input list. The order in which the data items appear in the input list, is the same order displayed to the operator when using an Input List Viewer tool.

Creating Recipes

Recipes are similar to a to-do list for the Xpress machine. You create a list of items that use analog, discrete, or string values to send all at once to the control machine, rather than sending each value one at a time. Use the Recipe editor to populate your recipe with data items that correspond to a particular value sent to the Xpress machine.

To create a recipe in your project

1. From the Project editor, select **New > Recipe** from the menu.

2. Enter a name for the new recipe. This name should relate to the type of list you are creating.
3. Select the OK button in the Recipe menu to accept the name and create the recipe.
4. Repeat steps 1 through 3 to create as many recipes as needed in your project.

Whenever a new recipe is created, by default the Recipe editor is displayed. Use the Recipe editor to add data items to your newly created recipe.

Notice that when you select the Project editor tab, the new recipe is displayed in the Project workspace. You can either highlight the recipe and select the Recipe editor tab or double-click on the recipe to return to the Recipe editor.

Adding and Editing a Recipe Item

To add or edit a data item in the Recipe editor:

1. From the Project workspace, either double-click the recipe you want to add items to or highlight the list and select the Recipe editor tab.

The Recipe editor is opened and the selected recipe is displayed. For information on creating a Recipe, refer to Creating Recipes.

2. Choose one of the following options

If you want to...	Then...
Add a new data item	Select New Item from the Recipe menu to add a new data item to the recipe.
Edit an existing data item	Highlight a recipe item and select Edit Item from the Recipe menu to edit the data item.

The Edit Recipe Item screen is displayed as shown below



The following table describes the properties on the Edit Recipe Item screen.

Property	Description
Name	Enter the name of the data item to add to your recipe, you can use up to 15 characters. The default name is ListItem001. If ListItem001 already exists, then the new name is ListItem002, and so on.
Send Value Input	Enter a tag name that specifies a location where you want the data value to be written to when the recipe is downloaded to the Xpress machine. The default value is blank.
Data Value	<p>Choose between an analog, discrete, or string value.</p> <p>Analog: Sends a numeric value to the Xpress machine. When an analog data type is selected, the Minimum and Maximum Value boxes become active. The State 0 and State 1 Label boxes remain greyed out.</p> <p>Discrete: Sends a discrete value (0 or 1) to the control machine. When a discrete data type is selected, the State 0 and State 1 Label boxes become active. The Minimum and Maximum Value boxes remain greyed out.</p> <p>String: Sends a string value to the Xpress machine. The State 0 and State 1 Label, Minimum and Maximum Value boxes remain greyed out.</p>

Value	<p>Enter an appropriate value for the data type selected.</p> <p>Analog: Enter a numeric value that is written to an input address each time the list is downloaded to the Xpress machine. During Runtime, you can edit this value before sending the list to the Xpress machine. The value is then checked to be sure it falls within the minimum and maximum range before it is sent to the Xpress machine. You define these ranges by specifying the Minimum and Maximum values. The Value field can also accept E and PI for analog values.</p> <p>Discrete: Enter either 0 or FALSE for off and 1 or TRUE for on.</p> <p>String: Enter a string that is written to an input address each time the list is downloaded to the Xpress machine. During Runtime, you can edit the string value before sending the list to the Xpress machine. A cursor is displayed in the value field, where you can use either a keyboard or the Keyboard pop-up tool to edit the string. String values need to be in quotes. For example, "Hello".</p> <p>In order to edit and save any one of these values in Runtime before sending it to the Xpress machine, you need to setup connections to your recipe.</p>
State 0 Label	<p>Enter the text you want to display when the discrete variable is 0 or Off. The field size for the label is 8 characters and the default value is Off.</p> <p>This option is only available when a discrete data type is selected.</p>
State 1 Label	<p>Enter the text you want to display when the discrete variable is 1 or On. The field size for the label is 8 characters and the default value is On. This option is only available when a discrete data type is selected.</p>
Minimum Value	<p>Enter the lowest value the operator can enter during Runtime. The value entered must be less than or equal to the Maximum Value, but greater than or equal to the Minimum Value.</p> <p>The default value is 0. If the field is left blank, it is set to 0. Negative values are acceptable. However, values below the Minimum value are invalid.</p>
Maximum Value	<p>Enter the highest value the operator can enter during Runtime. The value entered must be less than or equal to the Maximum Value, but greater than or equal to the Minimum Value.</p> <p>The default value is 100. If the field is left blank, it is set to 0. Negative values are acceptable. However, values below the Minimum value are invalid.</p>

Interact Xpress checks for illegal tag names, improper data, etc. If an error is found, that field is skipped. As each field is checked, the status field is left blank in the recipe editor for any fields found in error.

The Recipe Viewer Tool

Use the Recipe Viewer tool to display a recipe on your panel. The following table describes the properties available from the Recipe Viewer menu. For a step-by-step tutorial on using this tool, refer to How to Use the Recipe Viewer Tool.

Drag the tool from the tool box onto the panel, then resize and position it. To maintain aspect ratio, hold down the CTRL key while resizing from a corner. The following table describes the properties available from the Recipe tool menu.

Property	Description
Name	Enter a name for the Recipe Viewer, up to 32 characters. This name should relate to the type of list displayed in the Recipe Viewer tool. The default name is InputList001, and increments by one with each new viewer added.
Appearance	The appearance properties let you change the look of the Recipe Viewer. You can change the style, the display format and the display area. For details on appearance properties, see Changing Tool Appearance.
Accessibility	The accessibility properties determine whether or not a tool is visible to all users during Runtime. For more information, refer to Changing Tool Accessibility.

Creating Connections to the Recipe Viewer Tool

Once you've created your recipe and populated it with data items and corresponding values, you need to create connections to your recipe. Connections allow the Recipe Viewer tool to talk to other tools on the panel. By adding buttons, indicators, and display tools on your panel, you can save, load, and send your recipes to the Xpress machine. You can also add indicators and display tools to monitor the status of a recipe.

The following connections are available for use with a Recipe Viewer tool.

Property	Description								
List Status	Use this connection with a Message Display Tool to display status messages related to tool events. For example, when using a SendingList connection point, the Message Display tool displays the following information: <table border="1" data-bbox="406 1654 1312 1858"> <thead> <tr> <th>Action</th> <th>Message Displayed</th> </tr> </thead> <tbody> <tr> <td>The list is being sent, the connection point is TRUE.</td> <td>Sending input list...</td> </tr> <tr> <td>After the list has been sent, the connection point is FALSE.</td> <td>Input list sent.</td> </tr> <tr> <td>A failure occurred.</td> <td>Error sending input list.</td> </tr> </tbody> </table>	Action	Message Displayed	The list is being sent, the connection point is TRUE.	Sending input list...	After the list has been sent, the connection point is FALSE.	Input list sent.	A failure occurred.	Error sending input list.
Action	Message Displayed								
The list is being sent, the connection point is TRUE.	Sending input list...								
After the list has been sent, the connection point is FALSE.	Input list sent.								
A failure occurred.	Error sending input list.								

ListChanged	<p>You can use this connection with an Indicator tool to monitor whether or not the list has changed from the originally loaded list.</p> <p>In Runtime, when you are using the Recipe Viewer and you edit the list, the Indicator tool changes (and the ListChanged tag goes TRUE) to show that the list has been changed. When you save the list, the connection point is cleared and the Indicator tool returns to its original state (the ListChanged tag resets to FALSE). The connection point to the tool is also cleared when a new recipe is loaded.</p>
SendingList	<p>You can use this connection when an Indicator tool to monitor when the list is being sent to the Xpress machine. When the machine receives the SendingList signal, the connection point is TRUE and the Indicator tool changes. When all of the values in the recipe are sent and confirmation is received, the connection point automatically goes FALSE and the indicator tool is rest.</p> <p>You can refresh the panel while waiting for write confirmations.</p>
SendList	<p>You can use this connection with a Button tool to send the displayed recipe to the control address.</p>
LoadList	<p>You can use this connection with a Button tool to allow you to load a specified recipe into Recipe Viewer. A Selection List popup tool is displayed, allowing you to choose which recipe you want to load.</p>
ClearList	<p>You can use this connection with a Button tool to allow you to clear the Recipe Viewer.</p>
UploadList	<p>You can use this connection with a Button tool to load the data values from the Xpress machine to the Recipe Viewer. The operator can now save the list and change values as needed. The uploaded values are read from the input tag address ("Send Value Input") of each recipe item.</p>
SaveList	<p>You can use this connection with a Button tool to allow the operator to change a value in the Recipe and then save the changed list. Caution: Doing this writes over the original list, you will lose the original data value used in your recipe!</p>
SaveListAs	<p>You can use this connection with a Button tool to allow the operator to change a value in the recipe and then save the list with a new name. A Selection Entry tool is displayed, allowing you to enter a new name for the recipe. This prevents someone from writing over the original recipe values.</p>

CHAPTER 11: Using the Message Editor



Using the Message Editor

You can use the Message editor to setup messages you want to display during Runtime. In the Message editor, you create message files or tables that are referenced by the Message Display tool. For example, you can use the Message Display tool to display warnings, notes, and error messages on your runtime machine. The Message editor organizes all of these messages in one handy area as shown below.

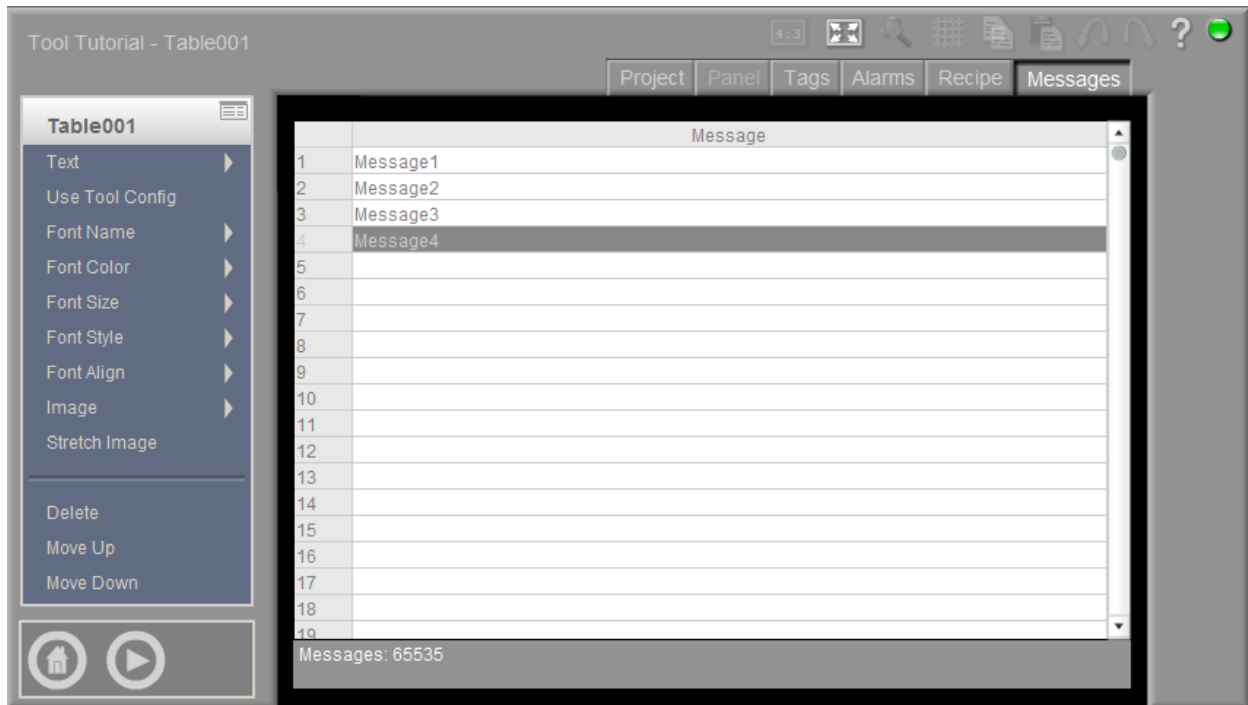

A message file lets you configure multiple lists of ASCII strings. A Message File can hold up to 535 messages. Use message files with a Message Display tool on your panel. Setup the Message Display tool to look at a register in the machine. The register contains a numeric data value in the machine. The data value indexes a string in the Message File.

Message Files are composed of message strings and corresponding numbers. The number associated with each message string is the data value in the register. The number of the message (data value in the register) tells the Message Display tool which message string in the message file to display.

Creating Message Tables

A message table lets you configure multiple lists of ASCII strings. A message table can hold up to 65,535 messages. Use message tables with a Message Display tool on your panel. Setup the Message Display tool to look at a register in the control machine or a local tag. The register contains a numeric data value and the data value indexes a string in the message table.

Message tables are composed of message strings and corresponding numbers. The number associated with each message string is the data value in the register. The number of the message (data value in the register) tells the Message Display tool which message string in the message table to display.

To create a message table in your project

1. From the Project editor, select New > Message Table from the menu.
2. Enter a name for the new message table.
3. Select the OK button in the Message Table screen to accept the name and create the message table.

Whenever a new message table is created, by default the Message editor is displayed. You are now working on an individual message table in your project. Notice that when you select the Project editor tab, the new message table is displayed in the Project workspace. You can either highlight the message table and select the Message editor tab or double-click on the message table to return to the Message editor.

Adding and Editing a Message

To add or edit a message:

1. Select your Message Table from the Project editor. The Message editor is opened. For information on creating a Message table, refer to [Creating Message Tables](#).
2. Select an empty row in the message table to add a new message. Select an existing row in the table to edit the message.
3. Select Text from the Table menu. The Text screen is displayed.
4. Enter the message you want to display in Runtime. Select the check in the upper-right hand corner of the screen to save your message and return to the Message editor.
5. With the new message highlighted in the table, you can control the look of the message displayed on the screen using the Font properties listed below.

Property	Description
Font Name	Choose a Sans Serif, Serif, or Monospace font.
Font Color	Choose a font color. For more information on customizing colors, refer to the Color Picker .
Font Size	Choose a font size.
Font Style	Add emphasis to your message with bold, italic, or underlined text.
Font Align	Align the text to the left, center, or right of the display box.
Image	Insert a graphic image as part of your message. For more information on working with images, refer to Importing and Exporting Images .
Stretch Image	Allows you to stretch the image to fit your display box.

CHAPTER 12:
Working with Animation

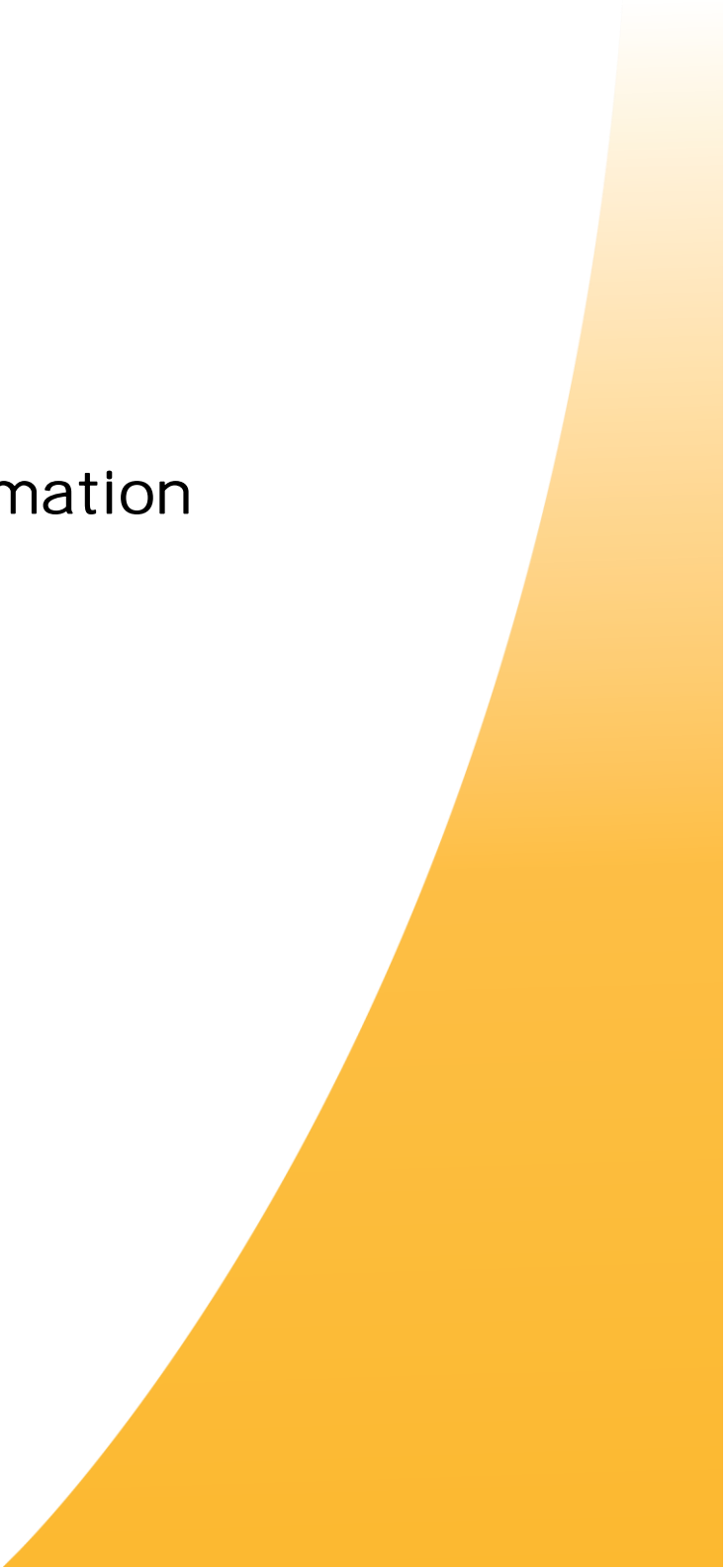

Working with Animation

Interact Xpress allows you to animate any graphic object. Graphic animation allows you to take a graphic representation of a machine or process that you have created (using the graphic tools) and then display it moving and/or changing color/state in Runtime. This gives the operator a clear understanding of machine operation.

Types of Animation

There are five types of animation in Interact Xpress, they are:

- Appearance
This type of animation allows you to alter the color, gradient, and the line style and width of an object in Runtime.
- Rotation
This type of animation allows you to gradually change the orientation of an object in Runtime.
- Transparency
This type of animation allows you to gradually change the visibility of an object in Runtime.
- Location
This type of animation allows you to gradually change the location of an object in Runtime. As a result, the object appears to move across the panel.
- Size
This type of animation allows you to gradually change the size of an object in Runtime.

Animating an Object

To animate a machine process or diagram, create your graphics, and then connect these graphics to tags. The tags reference data in memory addresses in your machine. Connect the graphics to tags using the Animations menu. The animation occurs when you run your application.

The basic steps to animate an object, are listed below. For details on using each type of animation, refer to the specific animation type.

1. Select the object you want to animate.
2. Click on the Appearance > Animations menu command.
3. Click on the New menu command.
4. Choose the type of animation you want to apply to your object (appearance, rotation, etc.).

You can apply multiple animations to one object. As you add animation connections, you will see the name of each new animation listed in the Animations menu. Animation connections are evaluated in order and are cumulatively applied to the object if the assigned tag value falls within the configured range or state. If no connections are applied, the object is drawn in its original form.

5. After choosing the type of animation you want to apply to your object, you need to set the animation properties. See [Animation Connections](#) for details.
6. Next, you need to setup the Output Tag to connect your object to your controller. See the [Tag Editor](#) for details.
7. Once your connections are set properly, you can run your project and view the animation. See [Running Your Project](#) for details.

CHAPTER 13: Using the Runtime Environment



Using the Runtime Environment

Interact Xpress has three main environments: the Shell, the Designer and a Runtime environment. The Runtime environment is where you test and run your project. For more information on Running Your Project, refer to the following: The Runtime Environment

- Customizing the Runtime Environment
- Testing Your Project in Runtime
- Entering Runtime
- Exiting Runtime

For information on using the design environment, refer to Using the Designer. For information on using the shell environment, refer to Using the Shell.

The Runtime Environment

Runtime mode refers to the software environment that lets you run your project. Runtime mode includes the ability to display and interact with panels, monitor real-time and historical alarms, communicate with the built in drivers, and serve tags to clients.

The server residing on the Interact Xpress box is the run mode component that drives your project. Your project can reside on a local PC, such as in offline development mode and remote access mode, or it can reside on the Interact Xpress box itself as in normal run mode operation.

Customizing the Runtime Environment

You can customize the Runtime environment for your project by:

- Configuring an exit key

You can opt to allow the operator to exit the Runtime environment through a combination of key strokes. You can choose from one of the following key combinations: None, SHIFT + Q, CTRL + Q, SHIFT + F3, or CTRL + F3.

The default setting is none, meaning you cannot use a keyboard shortcut to exit run mode, you must define an exit button on your panel. For more information on creating buttons, refer to The Button Tool.

- Displaying data errors

Interact Xpress has five types of Runtime errors: User Level, Syntax, Data, Math Scaling, and Write errors. You can choose to display these errors during Runtime when they are associated with a specific tool.

When enabled, an icon is displayed over the input tool during Runtime if an error is detected during data transfer. The icons are also displayed when monitored data has not been received from the machine.

To customize Runtime:

- Select **Runtime Settings** from the Project editor menu in the Design environment. The Runtime Settings menu is displayed.

Testing Your Project in Runtime

Once you have created your project in the Designer, you can test it in Runtime. When the project is ready, you can then transfer it to the Interact Xpress machine that will run the project.

To test your project, from the Designer:

- Press the Test Runtime icon or F5 to enter the test Runtime environment.

To exit the test Runtime environment:

- Press the stop icon to exit Runtime and return to the Designer.

Entering Runtime

You can enter Runtime either from the Shell environment or directly when starting the Interact Xpress box.

To enter Runtime from the Shell:

- Select the **Run** icon from the Interact Xpress Shell main screen. The Runtime environment is displayed and the project is connected to the server with live data.

In order to directly enter Runtime when starting up the Xpress box, you must enable the Runtime option. This option must be enabled for each user you want to start directly in Runtime. Depending on the access rights assigned to each user,

1. Select **User Admin** from the Setup Interact Xpress menu. The User Admin menu is displayed.
2. Select **Users** from the User Admin menu. The Users screen is displayed.
3. Select **Edit...** for each user you want to start in run mode.
4. Set the **Startup Program** option to Runtime. This option causes Interact Xpress to boot straight in to Runtime. The project is then connected to the server with live data.

For more information on user administration, refer to *Using the User Admin Menu*.

Exiting Run Mode

You can exit run mode by one of two methods:

- Selecting a button that has its type property set to exit.
- Selecting a button that has its switch input property set to the system tag "_HMI_Exit".

Pressing these buttons causes your project to exit and takes you to the Shell, if you have the proper access right. If you do not have access privileges to the Shell, the Shell ignores the command. Exiting run mode

will then take you to a logon page. You can change Shell access in the User Levels screen, for more information refer to *Using the User Admin Menu*.

Once you exit run mode, the communications session of the project ends. From the Shell, you can return to running or designing the project.

CHAPTER 14: Multiple Language Support



Multiple Language Support

Interact Xpress is divided into three translatable environments: Interact Xpress Manager, the Designer (including Shell), and a Runtime environment.

Translating Interact Xpress Manager

Interact Xpress Manager can be translated by editing the "OfflineLanguage_001.txt" file. This file is located in the folder where Interact Xpress Manager has been installed. By default this is in C:\Users\YourUserName\Documents\Parker.

Adding a Language

1. Open "OfflineLanguage_001.txt" in an editor such as Microsoft Excel.
2. The default column, named "ENU", contains all translatable strings for the Interact Xpress Manager. Copy this column and paste it into the next column.
3. In the newly added column, replace the first row string from "ENU" to one of the supported languages Unicode abbreviation. For example, if translating into Spanish (Spain) you would change the string to "ESN".
4. Replace text in each row you wish to translate then save the file.

Switching a Language

For Interact Xpress Manager to display the translated text, Regional Options in Windows must be set to match the added Language.

Translating Designer and Shell

Adding a Language

1. From Shell main menu select Import/Export, then select System Language.
2. Select one or more of the languages from the selection list then select Export.
3. Save this txt file to your computer, its name will default to "SystemLanguage.txt".
4. Open this file with an editor such as Excel.
5. This file contains a new language column with a three-letter heading which is the Unicode abbreviation for the exported language.
6. Translate the string in each row of the new column and save the file.
7. From Shell main menu select Import/Export, then select System Language.
8. Select Browse and choose the recently edited file. Note that the Browse button will only be available when Xpress is in disconnected mode.
9. Select Import. You can now switch the Designer and Shell interface to display in this language.

Switching Designer and Shell Language

1. From Shell main menu select Import/Export, then select System Language.
2. In the Imported Languages table, if it contains more than one language, select Set Current to switch the system language used in the Designer and Shell interface.

Remove a Language

1. From Shell main menu, select Import/Export then select System Language.
2. Select Remove next to the language you wish to delete in the Imported Languages table.

Translating Runtime

The project in Runtime mode can be translated to support multiple languages. The language must first be added to the project. Only then can a project be configured to use the imported language.

There are three ways to switch the project to display the translated language in Runtime.

- Using a Language button
- Using a system tag
- Using the logged-in users language

Adding a Language

1. From Shell main menu, select Import/Export, then select Project Language.
2. Select one or more of the languages from the selection list then select Export.
3. Save this txt file to your computer, its name will default to "ProjectLanguage.txt".
4. Open this file with an editor such as Excel.
5. This file contains a new language column with a three-letter heading which is the Unicode abbreviation for the exported language.
6. Translate string in each row of the new column and save the file.
7. From Shell main menu, select Import/Export, then select Project Language.
8. Select Browse and choose the recently edited file. Note that the Browse button will only be available when Xpress is in disconnected mode.
9. Select Import button. You can now switch the project to display in this language.

Working in Designer with the added Language(s)

1. After adding and importing a project language as described in the steps above, enter the Designer.
2. Under the project work space, select Language from the menu on the left.
3. Select a language of your choice.
4. Open a panel, labels on your tools should now be translated.

Switching the Runtime Language using a Language Button

1. In Designer, drag the Button tool from the tool box onto the panel, then resize and position it. To maintain aspect ratio, hold down the CTRL key while resizing from a corner.
2. Select Type - Language from the Button menu to set the button type to Language. Notice the Button menu changes depending on the type of button chosen.
3. Select Values - Language from the Button and select one of the imported languages.
4. In Runtime mode, pressing this button will switch the current Runtime session to the specified language.

Switching the Runtime Language using a System tag

1. In Designer, assign the _HMI_RegionCode system tag to the input value of an input tool such as a Numeric Entry.
2. Entering a Region Code number to this system tag in Runtime mode will cause the local client Runtime to switch its language to match the specified region code.

Switching the Runtime Language using the Logged-In User

1. From the Shell main menu, select User Admin then Users.
2. Choose to add or edit an existing user.
3. Select one of the languages from the Locale drop down box and choose OK.
4. The next time this user logs in and enters runtime, the project language will switch to match the language of that user.

Remove a Project Language

1. From the Shell main menu, select Import/Export then Project Language.
2. Select Remove next to the language you wish to delete in the Imported Languages table.

Supported Languages

The following table lists the Unicode abbreviations and code numbers for each supported language.

Unicode Abbreviation	Language	Code Number
ENU	English (U.S.)	1033
SQI	Albanian	1052
EUQ	Basque	1069
BGR	Bulgarian	1026
HRV	Croatian	1050
CSY	Czech	1029
DAN	Danish	1030
NLD	Dutch (Netherlands)	1043

MULTIPLE LANGUAGE SUPPORT

NLB	Dutch (Belgium)	2067
ENG	English (United Kingdom)	2057
ENA	English (Australian)	3081
ENC	English (Canadian)	4105
ENZ	English (New Zealand)	5129
ENI	English (Ireland)	6153
ENS	English (South Africa)	7177
ENJ	English (Jamaica)	8201
ENB	English (Caribbean)	9225
ENL	English (Belize)	10249
ENP	English (Republic of the Philippines)	13321
ENT	English (Trinidad and Tobago)	11273
ENW	English (Zimbabwe)	12297
FIN	Finnish	1035
FRA	French (France)	1036
FRB	French (Belgian)	2060
FRC	French (Canadian)	3084
FRS	French (Switzerland)	4108
FRL	French (Luxembourg)	5132
FRM	French (Principality of Monaco)	6156
DEU	German (Germany)	1031
DES	German (Switzerland)	2055
DEA	German (Austria)	3079
DEL	German (Luxembourg)	4103
DEC	German (Liechtenstein)	5127
HUN	Hungarian (Hungary)	1038
ITA	Italian (Italy)	1040
ITS	Italian (Switzerland)	2064
PLK	Polish (Poland)	1045
PTB	Portuguese (Brazil)	1046
PTG	Portuguese (Portugal)	2070
ROM	Romanian (Romania)	1048
RUS	Russian (Russia)	1049
SRB	Serbian (Cyrillic)	3098

SRL	Serbian (Latin) (Serbia)	2074
SKY	Slovak (Slovakia)	1051
ESS	Spanish (Argentina)	11274
ESB	Spanish (Bolivia)	16394
ESL	Spanish (Chile)	13322
ESO	Spanish (Colombia)	9226
ESC	Spanish (Costa Rica)	5130
ESD	Spanish (Dominican Republic)	7178
ESF	Spanish (Ecuador)	12298
ESE	Spanish (El Salvador)	17418
ESG	Spanish (Guatemala)	4106
ESH	Spanish (Honduras)	18442
ESM	Spanish (Mexican)	2058
ESI	Spanish (Nicaragua)	19466
ESA	Spanish (Panama)	6154
ESZ	Spanish (Paraguay)	15370
ESR	Spanish (Peru)	10250
ESU	Spanish (Puerto Rico)	20490
ESN	Spanish (Spain)	3082
ESY	Spanish (Uruguay)	14346
ESV	Spanish (Venezuela)	8202
SVF	Swedish (Finland)	2077
SVE	Swedish (Sweden)	1053

CHAPTER 15: Working with Communication Drivers

Working with Communication Drivers

In order for your application to communicate with a controller, you must configure the Xpress Manager to work with a COMM Server. To do this, select the COMM tab as shown below.

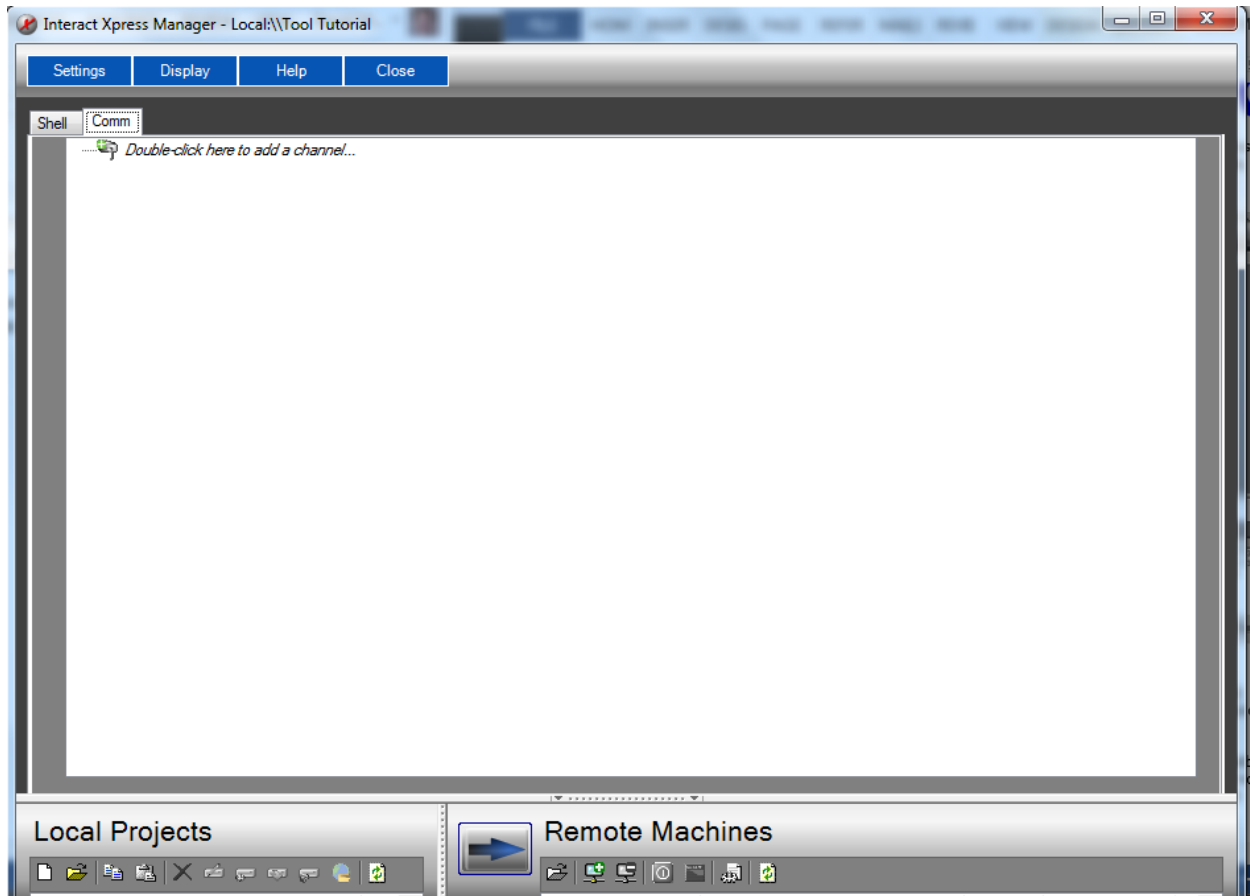

In the COMM server window, you can launch wizards that help you configure **channels** (communication drivers) and **devices** (models of those drivers). Once you have configured at least one channel and device, the Xpress Manager can communicate with the COMM server.

Interact Xpress is designed to run on a standard that makes it compatible with the manufacturers of many different communication drivers. For more information on the specific driver used with your system, refer to that driver's help file.

Adding a Channel

A channel is a way of communicating from the PC to one or more external devices. A channel can be used to represent either a serial port or a card installed in the PC.

Before adding devices to a project, you must define the channel to use when communicating with these devices. A channel and a device driver are closely tied. After creating a channel, only devices that the selected driver supports can be added to this channel.

To Add a Channel

Depending on the drivers you have installed, you can define a number of channels within a single application. To add a channel you must use the Channel Wizard. The wizard guides you through the channel definition process. To start the wizard:

1. Click on the COMM Tab in the Xpress Manager.

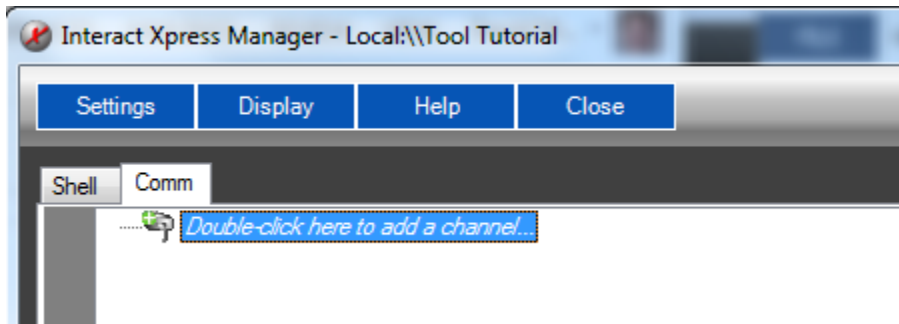

2. Double click on the Add Channel icon.
3. The wizard prompts with a list box of all the device drivers that are installed in the system. Choose your desired device driver.

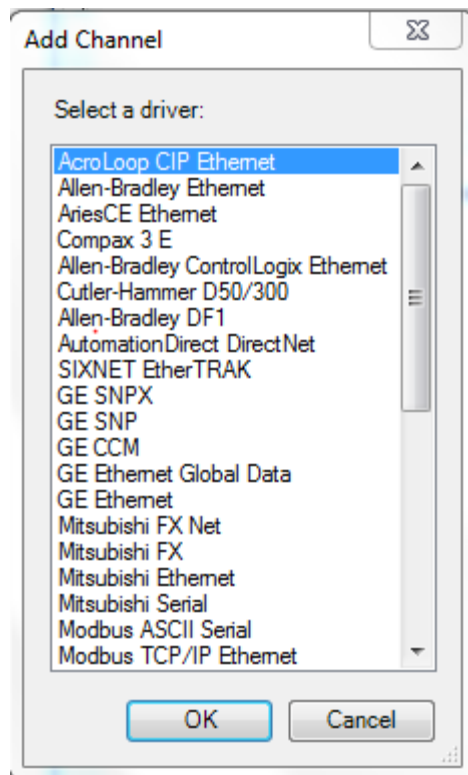

4. All serial drivers can be used with multiple channels in the same project.

If the device driver supports multiple channels, the wizard then prompts for the communication parameters to use. Multiple channels cannot share identical communication parameters, i.e. two serial drivers cannot use COM1. Refer to the manufacturer's documentation and the driver's online help for the correct communication parameters to use for a particular device.

5. The flow control settings for serial drivers are primarily used when connecting RS422/485 network devices to the RS232 serial port via a converter. Most RS232 to RS422/485 converters require either no flow control (None) or that the RTS line be on when the PC is transmitting and off when listening (RTS).
6. After selecting your device driver, the wizard prompts for a channel name. This name must be unique among all channels and devices defined in the project.

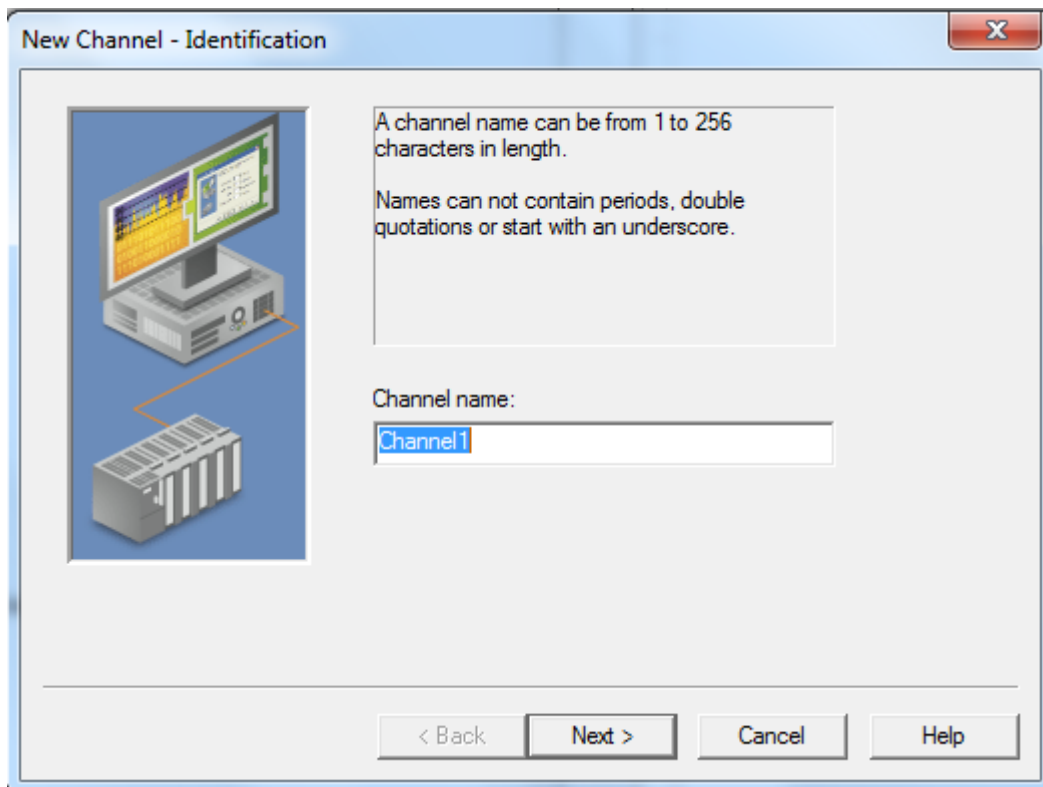

7. Depending on the driver you are using in your application, the number of dialog boxes in the wizard varies. Follow the instructions on the screen. For more information on the specific driver options used with your system, click on the Help button to access the driver's help file.
8. The wizard finishes with a summary of the new channel.

The channel appears in the Xpress Manager with a small red x below the channel icon. This x denotes that the channel does not contain a valid configuration. The channel is not valid because a device has not been yet added to the channel.

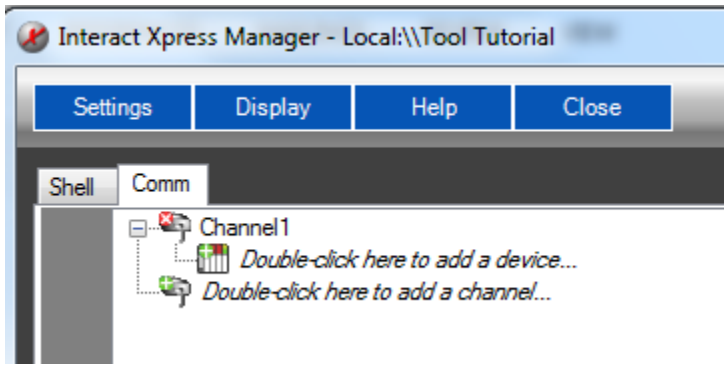

9. See Adding a Device to continue setting up the COMM server.

Adding a Device

Once you have defined a channel in your application, you must add a device to it. In most cases a device refers to the identification of a physical node or station on a communications link. A device is also referred to as a model. Only devices that the selected driver supports can be added to a channel.

A device can also be viewed strictly as a way of defining a connection to a specific point of interest in your application. In this respect, a device can be used as a term when describing the connection to a database object.

To Add a Device

After you have added a channel, the following Manager window is displayed.

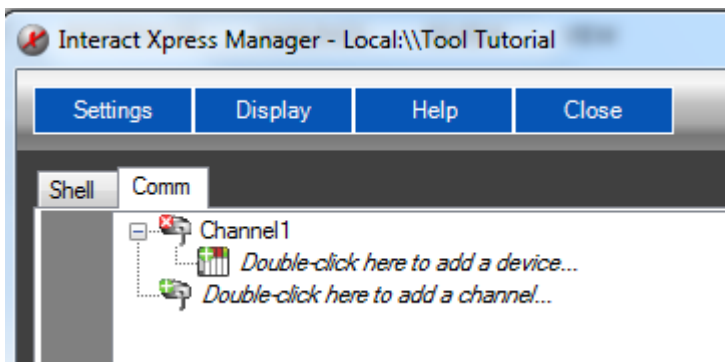

1. Double click the Add Device icon.

The New Device wizard launches as shown below. The device wizard lets you name the device and set the node ID.

2. Accept the default device name of Device1 as shown below.

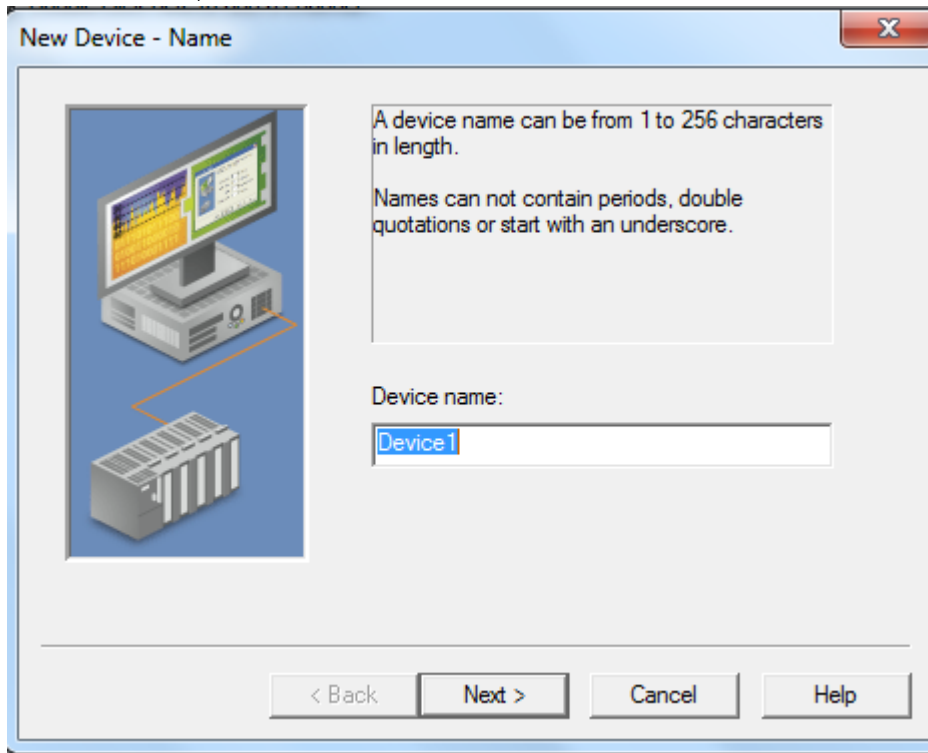

3. Depending on the driver you are using in your application, the number of dialog boxes in the wizard varies. Follow the instructions on the screen. For more information on the specific driver options used with your system, click on the Help button to access the driver's help file.

Once you have added both a channel and a device, your COMM Server window will appear as follows:

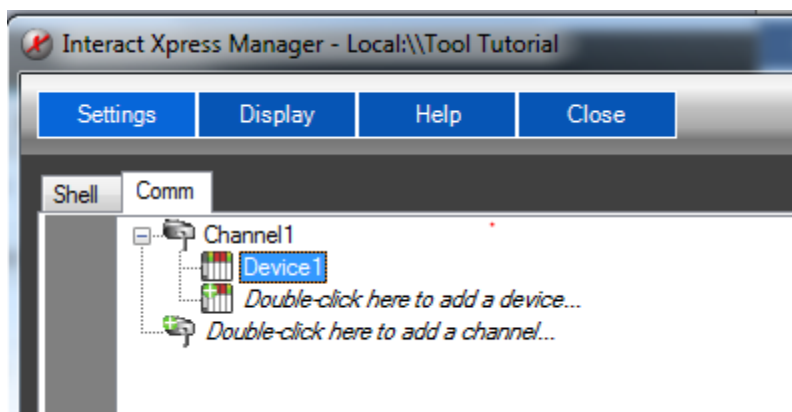

You can add multiple channels or multiple devices by following the same procedures when initially adding them. You can rename, edit, or delete the channels by right clicking on the channel or device. You can also expand or collapse the channels with the right mouse click.

With a channel and device added to your application, the COMM Server is ready to start providing data to clients. With the server's online full time mode of operation, the server can start providing data immediately.

